

HF Series

Dual Piston Pump



Operator's Manual

902688Rx REV B



Teledyne SSI 349 N. Science Park Road State College, PA 16803
<https://ssihplc.com> Phone: 814-234-7311 Fax: 814-238-7532
Email: ssi_sales@teledyne.com

Use and Disclosure of Data Information contained herein is classified as EAR99 under the U.S. Export Administration Regulations.
Export, reexport or diversion contrary to U.S. law is prohibited.

Warning Symbols and Task Specific Hazard Warnings:

The following warning symbols are present to alert you to risks that can arise when you install, operate or maintain the HF-Class pump. Such risks include chemical exposure, electric shocks, and others.

When the following symbols appear in the manual, as well as words such as “**CAUTION**, **NOTE**, or **WARNING**,” their accompanying text identifies the specific risks and explains how to avoid them. Teledyne SSI assumes no liability for the misuse of the information described in this manual in regards to installation, repair, or operation of the HF-Class pump and its components.

SAFETY SYMBOLS



CAUTION – HIGH VOLTAGE



CAUTION – REFER TO MANUAL



EARTH GROUND

SYMBOLES DE SÉCURITÉ



ATTENTION – HAUTE TENSION



ATTENTION – SE REPORTER AU MANUEL



TERRE

TABLE OF CONTENTS

1 INTRODUCTION	1-1
1.1 Description of the HF Series Pump	1-1
1.1.1 Pump Features.....	1-1
1.1.2 Wetted Materials.....	1-1
1.1.3 Self-Flushing Pump Heads.....	1-1
1.1.4 Self-Flush and Seal Life.....	1-2
1.1.5 No Flush Conversion Procedure.....	1-3

2 QUICK STARTUP GUIDE	2-5
2.1 Specifications for the HF Series Pump	2-6

3 INSTALLATION	3-7
3.1 Unpacking and Inspection	3-7
3.2 Location/Environment	3-7
3.3 Electrical Connections	3-7
3.4 Solvent Preparation	3-7
3.4.1 Solvent Out-gassing and Sparging.....	3-7
3.4.2 Cavitation.....	3-8
3.4.3 Filtration.....	3-8
3.4.4 Solvents With Harmful Effects.....	3-8
3.5 Instrument Installation	3-9
3.5.1 Mobile Phase Reservoirs.....	3-9
3.5.2 Self-Flush Solution.....	3-9
3.5.3 Inlet Tubing.....	3-9
3.5.4 Outlet Tubing.....	3-10
3.5.5 Priming the Pump and the Flushing Lines.....	3-10
3.6 Preparation for Storage or Shipping	3-10
3.6.1 Isopropanol Flush.....	3-10
3.6.2 Packaging for Shipping.....	3-10

4 OPERATION	4-1
4.1 Front Panel Controls and Indicators	4-1
4.1.1 Prime/Purge Valve.....	4-1
4.1.2 Filter/Outlet.....	4-1
4.2 Rear Panel Remote Input	4-1
4.3 Operator Instructions, Constant Flow	4-2
4.5 RS232 Information	4-7
4.6 REMOTE I/O	4-9

5 MAINTENANCE	5-1
5.1 Recommended Spare Parts Lists	5-1
5.2 Filter Replacement	5-1
5.2.1 Outlet Filter.....	5-1
5.3 Pump Head Assemblies	5-2

5.3.1 Removing the Pump Head.....	5-2
5.3.2 Cleaning the Pump Head Assembly.....	5-3
5.3.3 Replacing the Pump Head.....	5-4
5.4 Piston Seals	5-4
5.4.1 Removing the Seals	5-4
5.4.2 Replacing the Seals.....	5-5
5.4.3 Conditioning New Seals.....	5-5
5.5 Pistons	5-6
5.5.1 Cleaning the Piston	5-6
5.5.2 Replacing the Piston.....	5-6
5.6 Check Valve Cleaning and Replacement.....	5-6
5.6.1 Check Valve Cleaning	5-6
5.6.2 Check Valve Replacement	5-7
5.6.3 Self-Flush Check Valves.....	5-8
5.7 Cleaning the Pump.....	5-8
5.7.1 Cleaning the cabinet.....	5-9
5.8 Lubrication	5-9
5.9 Fuse Replacement.....	5-9
<hr/>	
6 QUICK GUIDE TO PROBLEM SOLVING	6-1
7 WARRANTY STATEMENT	2
8 COMPANY CONTACT INFORMATION.....	4

1 INTRODUCTION

This operator's manual contains information needed to install, operate, and perform user maintenance on the HF Series Pump.

1.1 Description of the HF Series Pump

The HF Series High Performance Liquid Chromatography (HPLC) Pump is designed to be a reliable component within a basic analytical or sophisticated research instrument system. While ideal for HPLC applications, the HF Series Pump is also useful as a metering pump for general laboratory or industrial use.

1.1.1 *Pump Features*

- Automatically disables the motor if the pressure exceeds the programmable maximum/minimum pressure limit.
- Integrated prime/purge valve.
- Inlet and outlet check valve.
- Graphical LCD front panel displays flow rate and operating pressure.
- Tactile response, chemically resistant front panel keypad.
- Servo motor design.
- RS232 serial communications for complete control and status monitoring.
- Rear panel input/output - remote start/stop and system error status.

1.1.2 *Wetted Materials*

Pump heads, check valve bodies, and tubing are made of type 316 stainless steel. Other integrated materials are Zirconia (piston), UHMWPE (seals), PTFE (outlet filter gaskets), PEEK, and Alumina (check valve internals).

1.1.3 *Self-Flushing Pump Heads*

Self-flushing pump heads provide continuous washing of the piston surface without the inconvenience of a manual flush or gravity feed arrangement. The self-flushing pump head uses a secondary seal and set of check valves to create a continuous and positive flow in the area behind the high-pressure pump seal. The flushing solution washes away any buffer salts that have precipitated onto the piston. If not removed, these precipitates can abrade the high-pressure seal and cause premature seal failure, leakage, and can possibly damage the pump.

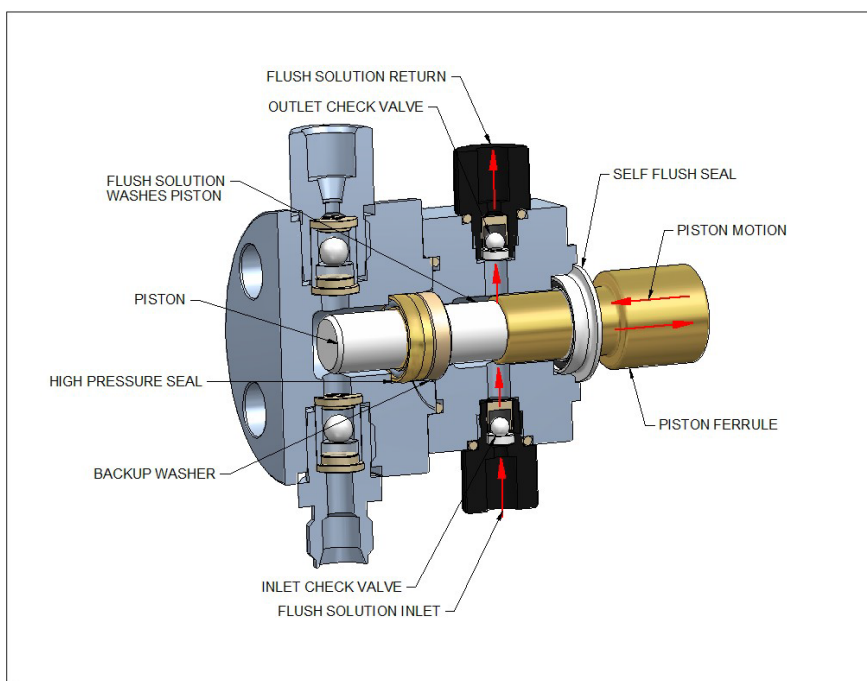

Self-Flushing Pump Head

1.1.4 **Self-Flush and Seal Life**

It is recommended that the Self Flush feature be used to improve seal life in a number of applications. In particular, (as stated above) if pumping Buffers, Acids/Bases or any inorganic solution near saturation, the pump should utilize the Self Flush feature. With every piston stroke, an extremely thin film of solution is pulled back past the seal. If this zone is dry (without use of Self Flush), then crystals will form with continuous operation, which will ultimately damage the seal.

Another application where Self Flush is highly recommended is when pumping Tetrahydrofuran (a.k.a. THF, Diethylene Oxide) or other volatile solvents such as acetone (Note: THF and most solvents are compatible only with all-Stainless Steel systems. THF will attack PEEK). Volatile solvents will dry rapidly behind the seal (without the use of Self Flush), which will dry and degrade the seal.

100% IPA, 100% Methanol, 20% IPA/water mix or 20% Methanol/water mix are the recommended options for the flush solution. Consult the factory if these are unacceptable for the application.

PUMP MODIFICATION WHEN SELF-FLUSH IS NOT USED

If the self-flush feature is not used, it is strongly recommended to carefully remove the self-flush seal with the seal tool provided and replace with the provided guide bushing (*reference the following instructions*). If this is not done; low flow rates, excessive noise and shortened pump life will result.

1.1.5 No Flush Conversion Procedure

Note: The conditioning of the seals may be required if the pump sits too long after the conversion. Conditioning is covered in 3.0.

1. Using a hex tool, remove the two head fasteners.

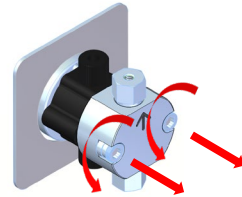

2. Carefully pull the pump head forward and off the guide pins. Keep the self-flush in place. Pull straight and slowly to prevent damage to the piston. Note: the back-up washer may remain on the piston. Carefully remove it and install when reassembling.

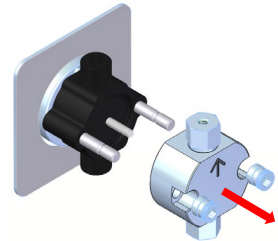

3. Carefully pull the flush housing forward and off the guide pins. Pull straight and slowly to prevent damage to the piston. Note: assure that the “O”-ring remains in the flush housing.

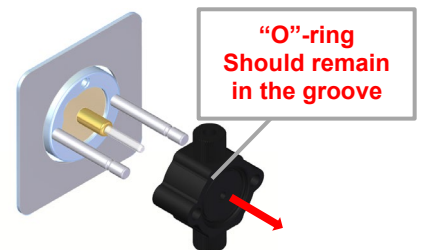

4. Using the supplied seal tool, carefully remove from the seal in the direction shown. Inlet and Outlet check valve capsules can be removed at this time also. Pliers may be necessary.

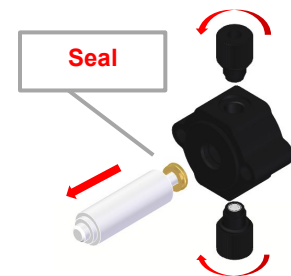

5. Press the supplied plug into the wash housing as shown.

Carefully slide the guide bushing onto the piston, in front of the backup plate.

Then, carefully slide the wash housing into place. Push onto guide pins straight and slowly to prevent damage to the piston.

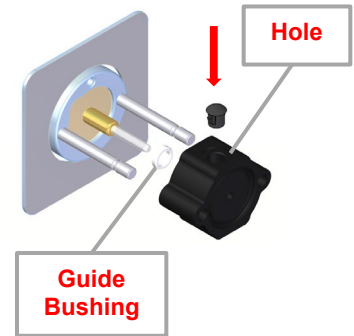

6. Carefully slide the back-up washer onto the piston, in front of the wash housing.

Then, carefully slide the pump head into place. Push onto guide pins straight and slowly to prevent damage to the piston.

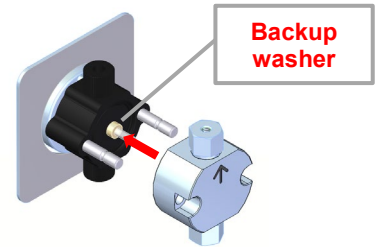

7. Using a hex tool, reinstall fasteners. As you tighten, alternate side-to-side until snug. Turn 1 flat past snug.

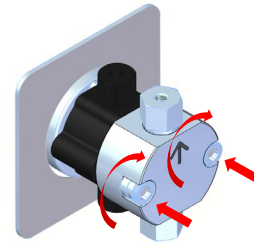

2 QUICK STARTUP GUIDE



CAUTION: Always release pressure from the pump slowly. A rapid pressure release could cause the pulse dampener diaphragm to rupture. Please refer to “Priming the Pump and Flush Line” for more information.

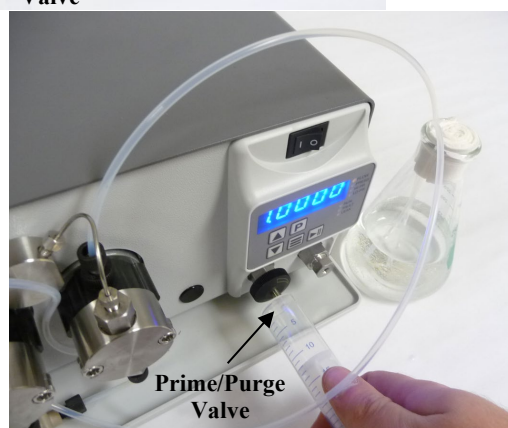
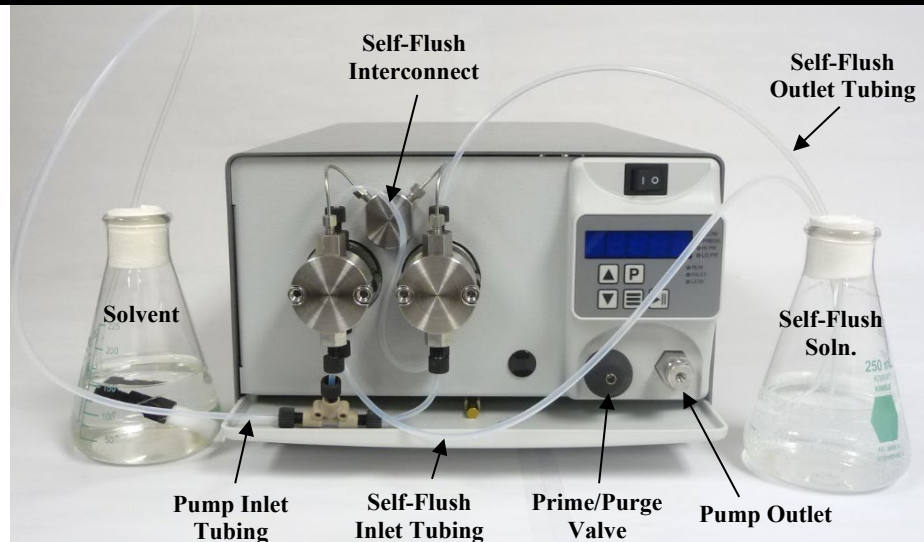

Self-Flush

- Connect self-flush solution **inlet** tubing to the **bottom-left** self-flush check valve, and the **outlet** tubing to the **top-right** self-flush check valve as shown.

Note: The self-flush housings are interconnected at the factory for flow-through with a single inlet/outlet.

- Attach syringe to outlet self-flush tubing, using the 1” lg piece of ¼” tubing.
- Draw syringe back to prime.
- After liquid has been pulled through the tubing into the syringe, remove syringe and place tubing in self-flush solution.

**Replace self-flush solution weekly.*

Note: If the self-flush feature is not used, refer to page 3 for proper pump modification.

Pump

- Connect pump inlet tubing to bottom of both pump heads as shown. *Make sure ferrule is in the correct position.*
- Attach syringe to Prime / Purge valve.
- Open Prime / Purge valve by turning knob counterclockwise one to two turns.
- Draw syringe back to prime. *Draw approximately 20 mL of fluid.*
- Press PRIME button (P), continue to draw on syringe until no bubbles are seen.
- Close Prime / Purge valve.
- Press PRIME button (P).
- Remove syringe.

** Replace solvent weekly.*



2.1 Specifications for the HF Series Pump

- Flow Rates0 to 300 mL/min (reference chart below)
- Pressure0 to 10,000 psi (reference chart below)
- Pressure Accuracy $\pm 0.5\%$ of full-scale pressure
- Pressure Zero Offset $\pm 1\%$ of full-scale pressure (± 100 psi)
- Flow Accuracy $\pm 5\%$
- Flow Precision0.5% RSD
- Dimensions (H x W x D)8.9" x 13.9" x 22.1" (22.6 x 35.3 x 56.1 cm)
- Weight50 lb
- Power120/240 VAC (Fluctuations not to exceed $\pm 10\%$)
- Environmental.....Indoor use only
- Altitude2000 M
- Temperature.....10 to 30° C
- Humidity20 to 90% Relative humidity
- Remote InputsRS-232
- Pulsation..... $\pm 9.0\%$ @ 150mL/min and 5000 psi (Constant Flow only)

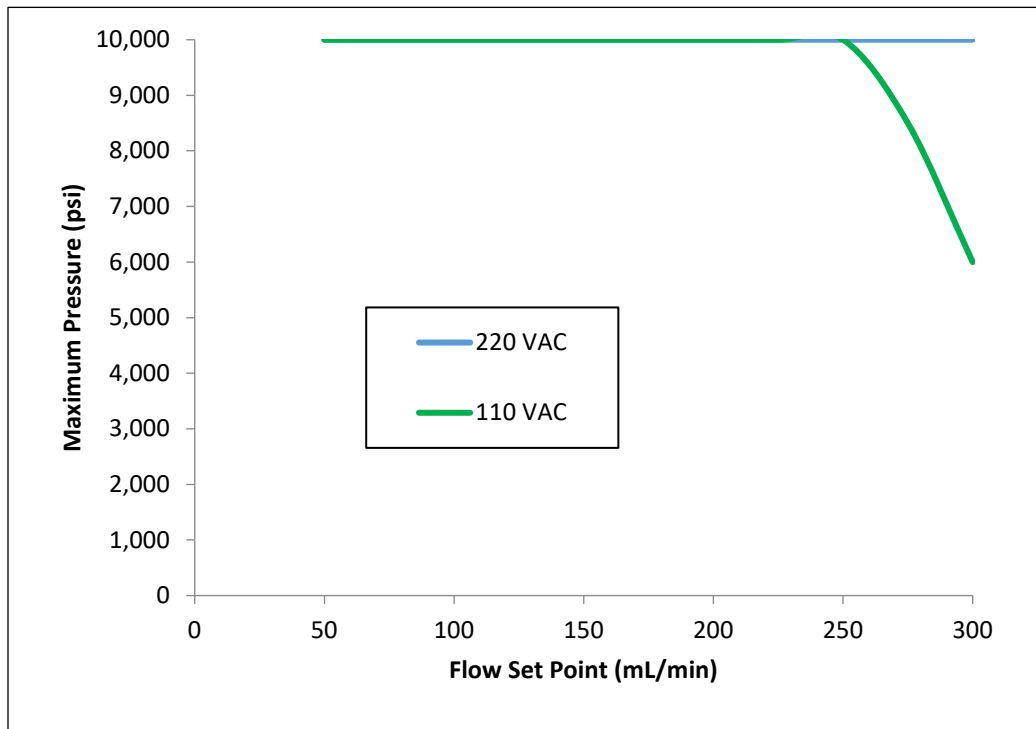

3 INSTALLATION

3.1 Unpacking and Inspection

Prior to opening the shipping container, inspect it for damage or evidence of mishandling. If it has been damaged or mishandled, notify the carrier before opening the container. Once the container is opened, inspect the contents for damage. Any damage should be reported to the carrier immediately. Save the shipping container. Check the contents against the packing list.

3.2 Location/Environment

The preferred environment for the HF Series Pump is normal laboratory conditions. The area should be clean and have a stable temperature and humidity. The instrument should be located on a stable flat surface with surrounding space for ventilation and the necessary electrical and fluid connections. (Reference IEC 1010 installation category II, and Pollution degree 2 environment.)

3.3 Electrical Connections

Unpack the HF Series Pump; position the pump so there is at least a four inch clearance on all sides to permit proper ventilation. Then plug the pump into a properly grounded electrical outlet.



WARNING: Do not bypass the safety ground connection as a serious shock hazard could result.

3.4 Solvent Preparation

Proper solvent preparation will prevent a great number of pumping problems. The most common problem is bubble formation, which may affect the flow rate consistency. Aside from leaky fittings, the problem of bubble formation arises from two sources: solvent out-gassing and cavitation. Filtration of HPLC solvents is also required.

3.4.1 Solvent Out-gassing and Sparging

Solvent out-gassing occurs because the mobile phase contains dissolved atmospheric gases, primarily N₂ and O₂. These dissolved gases may lead to bubble formation and should be removed by degassing the mobile phase before or during use. The best practical technique for degassing is to sparge the solvent with standard laboratory grade (99.9+%) helium. Helium is only sparingly soluble in HPLC solvents, so other gases dissolved in the solvent diffuse into the helium bubbles and are swept from the system. Solvent filtration is not an effective alternative to helium degassing.

It is recommended that you sparge the solvent vigorously for 10 to 15 minutes before using it. Then maintain a trickle sparge during use to keep atmospheric gases from dissolving back into the mobile phase. The sparged solvent must be continually blanketed with helium at 2 to 3 psi. Non-blanketed sparged solvents will have atmospheric gases dissolved back into the mobile phase within four hours.

Solvent mixtures using water and organic solvents (like methanol or acetonitrile) hold less dissolved gas than pure solvents. Sparging to reduce the amount of dissolved gas is therefore particularly important when utilizing solvent mixture.

Even with sparging some out-gassing may occur. A backpressure regulator installed after the detector flow cell will help prevent bubbles from forming and thus limit baseline noise.



WARNING: Always release pressure from the pump slowly. A rapid pressure release could cause the pulse damper diaphragm to rupture.

3.4.2 *Cavitation*

Cavitation occurs when inlet conditions restrict the flow of solvent and vapor bubbles are formed during the inlet stroke. The key to preventing cavitation is to reduce inlet restrictions. The most common causes of inlet restrictions are crimped inlet lines. Inlet lines with tubing longer than 48" (120 cm) or with tubing of less than 0.085" (2 mm) ID may also cause cavitation.

Placing the solvent reservoirs below the pump level also promotes cavitation. The optimal location of the reservoirs is slightly above the pump level, but it is adequate to have them on the same level as the pump.

3.4.3 *Filtration*

Solvent filtration is good practice for the reliability of the HF Series Pump and other components in a HPLC system. Solvents should always be filtered with a 20 micron filter prior to use (inlet filter not included with pump). This ensures that no particles will interfere with the reliable operation of the piston seals and check valves. Solvents in which buffers or other salts readily precipitate out will need to be filtered more often. After filtration, the solvents should be stored in a closed, particulate-free bottle.

3.4.4 *Solvents With Harmful Effects*



All portions of the HF model pump that contact mobile phase are manufactured of type 316 stainless steel, sapphire, ruby, Zirconia, PEEK, or fluorocarbon polymer. Some of these materials are extremely sensitive to acids (including some Lewis acids) and acid halides. Avoid using solvents that contain any amount of hydrochloric acid. Some solvents you should specifically avoid are:

Aqua Regia	Hydrochloric Acid
Bromine	Hydrofluoric Acid
Chlorine Anhydrous	Hydrofluorsilicic Acid
Copper Chloride	Hydrogen Peroxide
Ferric Chloride	Iodine
Ferrous Chloride	Mercuric Chloride
Freon 12 (wet)	Guanidine
Hydrobromic Acid	

In addition, some users of HPLC systems have observed that chloroform and carbon tetrachloride slowly decompose to liberate hydrochloric acid, which, as noted above, attacks stainless steel. Do not leave these solvents in the systems for a prolonged period.

It is also recommended to avoid ammonium hydroxide. Although ammonium hydroxide will not harm the pump itself, it is likely to damage the stator and rotor in injection valves.

3.5 Instrument Installation

3.5.1 *Mobile Phase Reservoirs*

The mobile phase reservoir should be placed at the same level or slightly higher than the pump, never below the pump, and the inlet tubing should be as short as practical. These steps minimize pressure losses on the inlet side of the pump during refill and help to avoid bubble formation. These steps are particularly important when using high vapor pressure solvents (hexane, methylene chloride, etc.). Mobile phases should be degassed, filtered and covered. (See Section 2.4.)

3.5.2 *Self-Flush Solution*

Self-flush heads require 250-500 mL of flushing solution. See section 1.1.4 for self-flush solution recommendations. A pH indicator that will indicate the concentration of salts in the solution is recommended as a reminder to change the solution. This flush solution should be replaced with a fresh solution weekly to avoid frequent pump maintenance.



WARNING: If you do not use the self-flush feature of this pump, you must carefully remove the self-flush seal with the seal tool provided, replace with the guide bushing provided (See illustration below). If this is not done; low flow rates, excessive noise and shortened pump life will result.

3.5.3 *Inlet Tubing*

All inlet lines are supplied in a 48" (122 cm) length, with a 3/16" ID and a 1/4" OD, and are made of FEP.

3.5.4 *Outlet Tubing*

Outlet tubing (not supplied with the pump) should have a 1/8" outer diameter. It is available in type 316 stainless steel. The tubing must be cut squarely with no burrs. The tube itself should not be crimped and the center hole must be open. A tubing cutter is recommended for cutting stainless steel tubing.

3.5.5 *Priming the Pump and the Flushing Lines*

Be sure all of the connections downstream of the prime/purge valve are closed. Connect a syringe to the prime/purge valve. Open the prime/purge valve 1 to 2 turns (counter-clockwise). Run the pump at a flow rate of 30 to 50 mL/min. Prime the pump by pulling mobile phase and any air bubbles through the system and into the syringe (a minimum of 20 mL). Close the prime/purge valve and stop the pump.

3.6 **Preparation for Storage or Shipping**

3.6.1 *Isopropanol Flush*

Disconnect the outlet tubing from the pump. Make sure the inlet tubing is connected to the pump and solvent is available to the inlet. Open the prime/purge valve and use a syringe to draw a minimum of 50 mL. Close the prime/purge valve and pump a minimum of 50 mL of isopropanol to exit. Leave the inlet tubing connected to the pump. Plug the outlet port with the shipping plug, leave a length of outlet tubing on the pump, or cover the outlet port with plastic film.

3.6.2 *Packaging for Shipping*



CAUTION: Re-package in the original carton, if possible. If the original carton is not available, wrap the pump in several layers of bubble wrap and cushion the bottom, top, and all four sides with 2" of packaging foam. Although heavy, an HPLC pump is a delicate instrument and must be carefully packaged to withstand the shocks and vibration of shipment.

4 OPERATION

4.1 Front Panel Controls and Indicators

4.1.1 Prime/Purge Valve

The prime/purge valve vents the flow to atmosphere and permits efficient priming of the HF Series Pump. When the valve is closed firmly (fully clock-wise), high-pressure flow is directed to the Filter/Outlet port. When the valve is opened (counter clock-wise) one-half to one full turn, pressure is vented and flow exits through the drain port in the prime/purge valve stem assembly. Suction with a Luer tip syringe at the drain port will purge air bubbles from the pump and reservoir lines (provided there are no open valves to lines downstream at the injector/column interface). To prime the pump, draw about 20 to 30 mL of mobile phase.

4.1.2 Filter/Outlet

A high-pressure in-line filter is included at the output of the HF-Class pump. The Filter/Outlet port is the high pressure filter closure, is designed for 1/8" o.d. tubing connections.

4.2 Rear Panel Remote Input

An RS-232C modular jack is provided on the back panel. A computer, with appropriate software, can be used as a remote control device for pump operation via this connection.



Figure 3-2. HF Series Pump Rear Panel

4.3 Operator Instructions, Constant Flow

The HF Series Pump can be purchased as a Constant Flow (CF) pump. The major components common to both versions include a servo motor, servo motor drive, and Human Machine Interface / Programmable Logic Controller (HMI/PLC). This section covers the operating instructions for the Constant Flow pump.

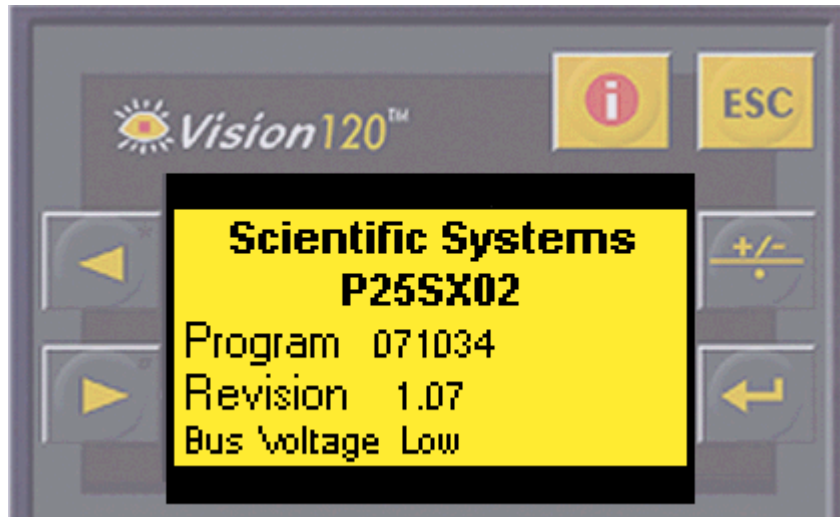

Figure 3-3. Splash Screen, Constant Flow

On power turn on, a temporary Splash Screen (Figure 3-3) will display for 10 seconds, followed by the Operating Screen (Figure 3-4), which is the primary display screen. The Splash Screen displays the SSI pump identification number, the firmware (program) part number and revision, and the voltage level of the motor drive power bus, which is equal to the AC input voltage.

The bus voltage level is dependent on the incoming AC line voltage, and will be displayed either as “Low” (110VAC) or as “High” (220VAC). A high voltage bus will allow the pump to operate at its maximum conditions. A low bus voltage will reduce the maximum operating capability of the pump. See Section 1.2 for a full description of operating parameters.

The CF main menu structure consists of three screens: the Operating Screen, the Setup Screen, and the Password Screen. The left and right arrow buttons will cycle through these screens in the following order:

Operating Screen ◀▶ Setup Screen ◀▶ Password Screen ◀▶ Operating Screen

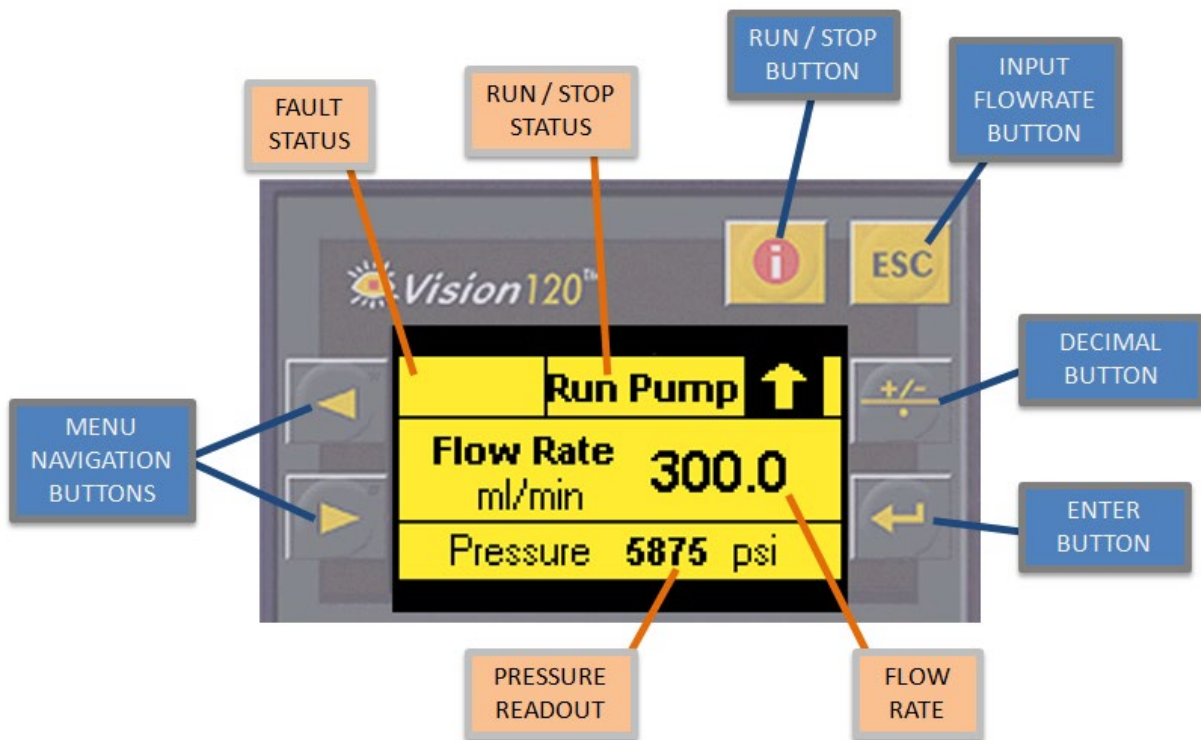

Figure 3-4. Operating Screen, Constant Flow

The Operating Screen contains the following controls and information:

- Fault Status display
- Run/Stop Status display
- Run/Stop pump control button
- Input Flowrate button
- Sign/Decimal input button
- Flow Rate display / input field, in ml/min
- Operating pressure display, in psi
- Menu navigation buttons

When the Operating Screen is initially displayed, the FLOW RATE input field will be active, indicated by a blinking cursor located in the FLOW RATE field. To input a flow rate in ml/min, press the corresponding number keypad buttons, located directly below the display screen, and the DECIMAL BUTTON if required. It is not necessary to input a zero decimal value – the decimal value will default to zero if no decimal value is entered. Accepted flow rate values range from 0.0 to 300.0 ml/min. Press the ENTER button to accept the new flow rate setting. Note that the flow rate set point will not be saved until the ENTER button is pressed. The cursor will stop blinking, indicating that the field is no longer ready to accept a new value. To input a new flow rate value, press the INPUT FLOWRATE (ESC) button. As before, a blinking cursor indicates that the FLOW RATE field is ready to accept a new set point.

The RUN /STOP BUTTON will either start or stop the pump’s motor, depending on the current condition. If the pump is stopped (default condition), the display will show “Run Pump”; pressing the RUN/STOP BUTTON will run the pump. If the pump is running, the display will show “Stop Pump”; pressing the RUN/STOP BUTTON will stop the pump. Note that the flow rate set point must be non-zero and all faults must be cleared in order for the pump to run.

The PRESSURE READOUT field will display the current operating pressure, read by a pressure sensor located inside the pump cabinet.

The FAULT STATUS field will display the current fault status. If no faults exist, the field will be blank. If a fault exists, the field will display “FAULT”. An existing fault status will prevent the pump’s motor from running. All faults must be cleared to operate the pump. Fault details can be found on the Setup Screen, which can be accessed by pressing the right arrow button from the Operating Screen. The Setup Screen is described below.

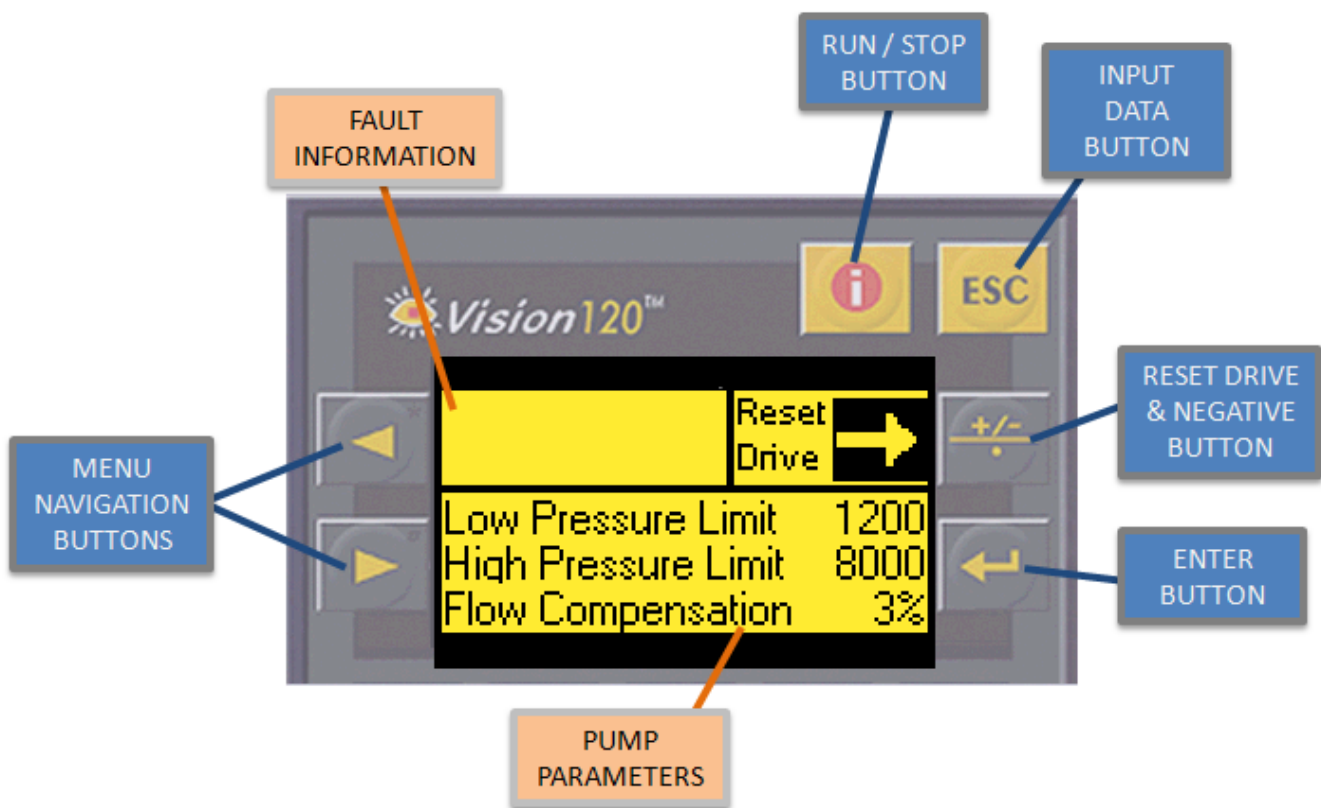

Figure 3-5. Setup Screen, Constant Flow

The Setup Screen contains the following controls and information:

- Detailed fault information
- Run/Stop pump control button
- Input data button
- Dual-purpose RESET DRIVE / negative sign input button for Flow Compensation
- High and Low Pressure Limit display / input fields
- Flow Compensation display / input field
- Menu navigation buttons

The FAULT INFORMATION field provides details on any existing fault conditions. If no faults are present, the field will be blank. Possible fault messages include:

Low Pressure Fault (PLC)

- High Pressure Fault (PLC)
- Drive Fault (Unspecified, Motor Drive)
- Drive Fault Corrupt Flash (Motor Drive)
- Drive Fault A/D Out of Range (Motor Drive)
- Drive Fault Short Circuit (Motor Drive)
- Drive Fault AMP Overtemp (Motor Drive)
- Drive Fault Motor Overtemp (Motor Drive)
- Drive Fault Over Voltage (Motor Drive)
- Drive Fault Under Voltage (Motor Drive)
- Drive Fault Feedback Error (Motor Drive)
- Drive Fault Motor Phasing Error (Motor Drive)
- Drive Fault Following Error (Motor Drive)
- Drive Fault Over Current (Motor Drive)

The motor drive unit will attempt to automatically reset following a fault. The RESET DRIVE button will also perform a reset of the motor drive unit, and also set the flow rate to zero. If a motor drive fault cannot be resolved by the RESET DRIVE button, power cycle the pump to clear the fault. If a motor drive fault condition persists, please consult the SSI Service Department.

Multiple faults/warnings are displayed by using the “ESC” key to step turn the active messages.

As with the Operating Screen, when the Setup Screen initially loads, the data entry mode will automatically be active, indicated by a blinking cursor in the Low Pressure Limit data input field. As before, the INPUT DATA BUTTON (ESC) will also activate data entry mode to allow new values to be entered. To input a new value in the Low Pressure Limit data field, use the corresponding numeric keypad buttons located directly below the display to input a value between 0 and 9999. The Low Pressure Limit will disable the motor and generate a Low Pressure Fault condition when the operating pressure drops below this value. The value of the Low Pressure Limit should not exceed the value of the High Pressure Limit. Press the ENTER button to accept the value; this will move the cursor to the High Pressure Limit data field. To input a value in the High Pressure Limit data field, use the corresponding numeric keypad buttons to input a value between 0 and

9999. The High Pressure Limit will disable the motor and generate a High Pressure Fault condition when the operating pressure exceeds this value. Press the ENTER button to accept the value; this will move the cursor to the Flow Compensation data field.

The Flow Compensation data field allows you to adjust the flowrate of the pump to accommodate various operating conditions, such as variability due to solvent compressibility or temperature affects. This factor will adjust the flow rate in full-step percentage increments. Note that the adjustment step size is calibrated using water as a solvent, at room temperature. The actual percentage change seen in your system may vary. Allowable range for this adjustment factor is -15% to +15%. To input a negative value (decreased RPM), use the NEGATIVE BUTTON followed by a numeric value. To input a positive adjustment (increased RPM), simply input the numeric value – no sign is needed. Press the ENTER button the accept the value. This adjustment will become active the next time the pump’s motor is started. If the motor is currently running, it is necessary to stop and then start the pump for this value to be implemented. If the motor is stopped, the adjustment will simply take effect the next time the motor is started.

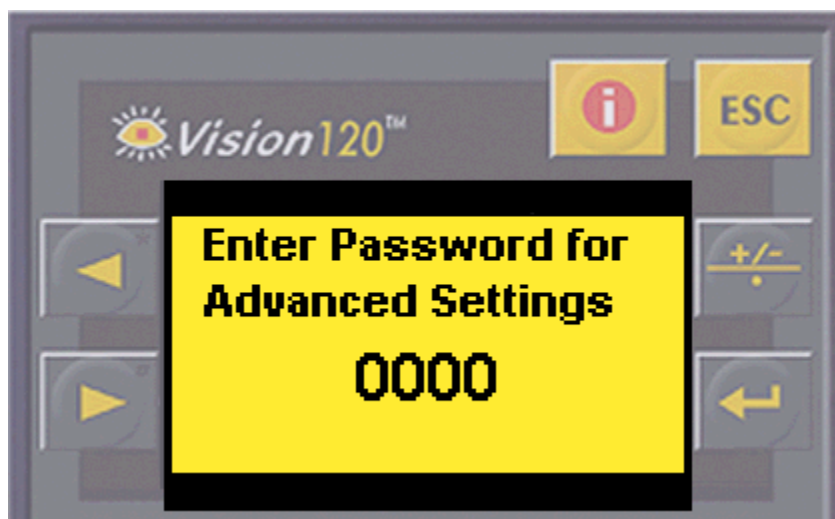

Figure 3-6. Password Screen

The Password Screen restricts access to the Advanced Settings menu, which is used for factory configuration of each instrument.

4.5 RS232 Information

RS232: Pinout

Diagram	Pin Number	RS232: Function
	1	DTR signal
	2	0V reference
	3	TxD signal
	4	RxD signal
	5	0V reference
	6	DSR signal

Figure 3-14. RS-232 Pinout

The HF Series Pump is configured for the following communication parameters:

9600 baud, no parity, 8 data bits and 1 stop bit.

Two cable assemblies with adapters are supplied: one “Quick Set Cable Assembly” to allow user communications with the instrument, and one “PLC PROGRAMMING CABLE” to allow access to the PLC, if necessary.

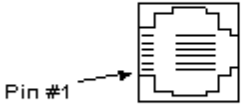
Refer to the following page for a complete list of available commands.

Command	Description	Display or PC Reply
RU	Run Pump	
ST	Stop Pump	
FOXXXX	Flow Rate 4 Digits (Actual Flow Rate X 10) **	FO0500 = 50 ml/min
CC	Read Actual Pressure & Flow Rate	OK XXXX, XXX.X (or XX.XX)
PR	Read Actual Pressure	OK XXXX
CS	Read Flow Rate	XXXX,
	Over Pressure Setting	XXXX,
	Under Pressure Setting	XXXX, PSI
	Head Type Number **	See Chart
	Pump Running or Stopped **	1 for Running, 0 for Stopped
	Pressure Board Installed	1 for Installed, 0 for None
PI	Read Flow Rate	
	Pump Running or Stopped **	1 for Running, 0 for Stopped
	Head Type Number **	See Chart
	Pressure Board Installed	1 for Installed, 0 for None
	External Voltage or Frequency Setup	1 for Voltage, 0 for Frequency
	Frequency Controlled & Running	1 if Running under Frequency Flow Control, else 0
	Voltage Controlled & Running	1 if Running under Voltage Flow Control, else 0
	Upper Pressure Faulted	1 Faulted, else 0
	Under Pressure Faulted	2 Faulted, else 0
	Priming	1 if Priming, else 0
	Keyboard Lockout	1, Keyboard Lockout, 0 Else
	External Start	1 if Running by External Start, else 0
	External Stop	1 if Stopped by External Stop, else 0
	External Enable	1 if External Control Enabled, else 0
	0	Unused
	Motor Stall Fault	1 if Stall Faulted, 0 Else
UPXXXX	Set the Upper Pressure Limit	Must be in the pumps limits else "ER/" is returned
LPXXXX	Set the Lower Pressure Limit	Must be in the pumps limits else "ER/" is returned
SPXXXX	Set Operational Pressure	SP4500 = 4500 PSI Constant Pressure Flow Output
RH	Read Head Type	Returns OK, 7/
ID	Returns the Software and Version Number	XXXXVXXX to PC
RE	Resets Pump to Default Factory Settings	Res
RC	Returns the Compensation	XX = Compensation factor without rapid refill mode
RF	Return the Fault Status bits	X,X,X for Stall Fault, 1 for Faulted, 0 Else

4.6 REMOTE I/O

The HF Series Pump is also equipped with a 9 pin DE-9 style connector, located on the rear of the enclosure. This connections allows remote starting and stopping of the pump through a dry contact relay, and also provides fault status of the pump via 2 dry contacts (one normally open and one normally closed).

Pin	Function
1	+24VDC
2, 3	Normal Closed contact indicating normal pump operation
4, 5	Normal Open contact indicating normal pump operation
6	Enable (Connect to pin 1 to activate Run/Stop inputs)
7	Run (>100 ms high pulse to run pump)
8	Stop (>100 ms high pulse to stop pump)
9	0 VDC (common)

5 MAINTENANCE

Cleaning and minor repairs of the HF model pump can be performed as outlined below.

5.1 Recommended Spare Parts Lists

Pump specific Recommended Spare Parts Lists are included with this pump in the box. The spare parts list can also be accessed through our website, by entering the pump's serial number at the following address:

<https://www.teledynessi.com/spare-parts-look-up>

The pump serial number is included on the front cover of the manual, and on the back of the pump.

Note: Lower than normal pressure, pressure variations, or leaks in the pumping system can all indicate possible problems with the piston seal, piston, or check valves. Piston seal replacement could be necessary after 1,000 hours of running time. See Section 5.2.3.

5.2 Filter Replacement

5.2.1 Outlet Filter

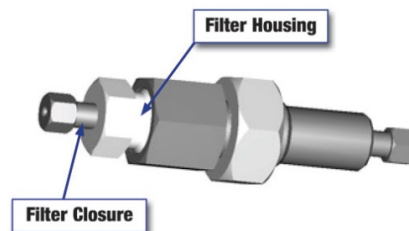

Figure 5-1, Outlet Filter

To service the outlet filter:

1. Using a 5/8" wrench to hold the filter housing at the pump, and a 1/2" wrench to remove the filter closure, remove the filter closure assembly.



CAUTION: Do not use a metal object such as a screwdriver or paperclip to remove the seal. Doing so can scratch the precision surface of the seat and may cause the filter to leak.

2. Use a seal insertion/removal tool or a non-metallic object (such as a wooden toothpick) to remove the large seal that remains in the housing.
3. Unscrew the old filter and remove the small seal from the filter closure.
4. Place one of the small seals included in the replacement element kit over one of the new filters from the kit. Screw the new filter into the filter closure (finger tight).

5. Place one of the large seals from the replacement kit on the filter closure. Insert the filter closure into the housing and tighten $\frac{1}{4}$ turn after seating.

5.3 Pump Head Assemblies



CAUTION: When working with aggressive or toxic solvents, residual amounts of these chemicals could be present in the system.

5.3.1 Removing the Pump Head

The pump head assembly is shown below in Figure 4-1. Note that there is a guide bushing used in place of the self-flush seal when the self-flush is not being used.

1. Turn OFF the power to the HF model pump.
2. Unplug the power cord.
3. Remove the inlet line from the mobile phase reservoir. Be careful not to crimp the FEP tubing.
4. Remove the inlet line from the inlet check valve.
5. Remove the outlet line from the outlet check valve.
6. Use a $\frac{5}{32}$ Allen wrench to carefully remove the four screws at the front of the pump head, taking care not to lose the split-ring lockwashers.



CAUTION: Be careful not to break the piston when removing the pump head. Twisting the pump head can cause the piston to break.

7. Carefully separate the pump head from the pump.
 - a. Move the pump head straight out from the pump and remove it from the piston. **Be careful not to break or damage the piston.**
 - b. Remove the seal and seal backup washer from the piston if they did not stay in the pump head.
 - c. Remove the O-ring.
8. Carefully separate the flush housing from the pump. Move the flush housing straight out from the pump and remove it from the piston. Be careful not to break or damage the piston. Also remove the self-flush seal from the piston if it did not stay in the flush housing.

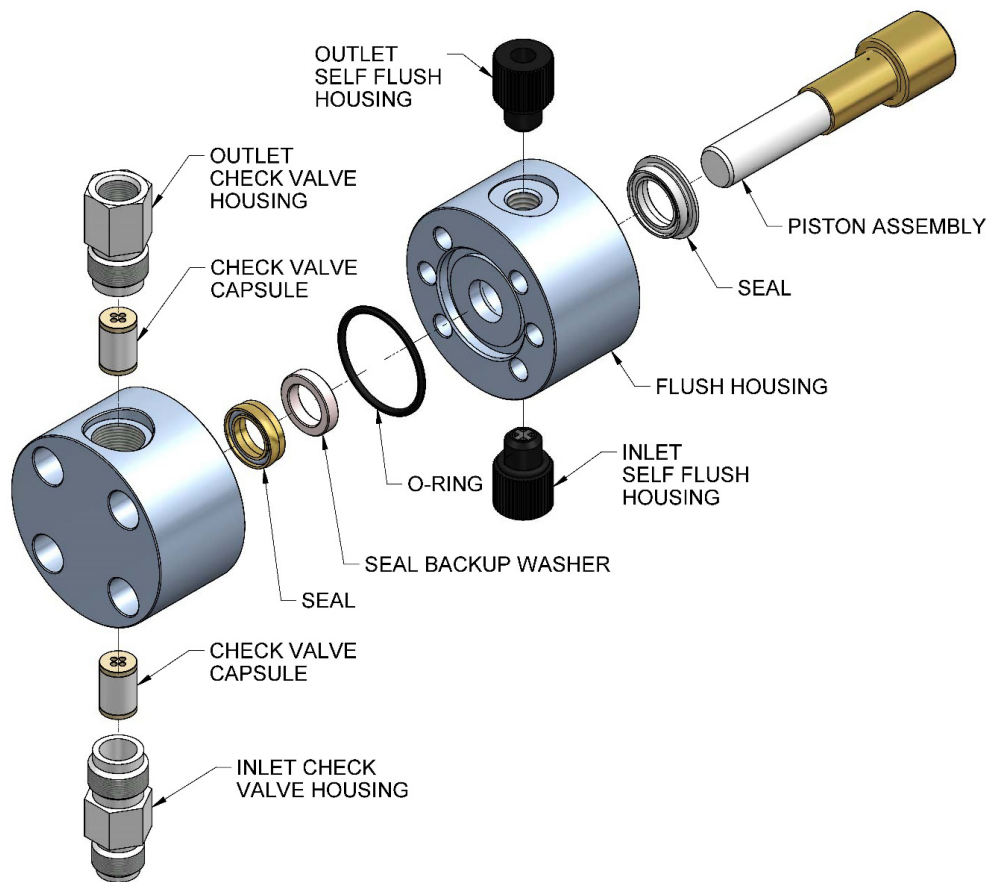

Figure 4-1. Stainless Steel Self-Flushing Pump Head Assembly

5.3.2 Cleaning the Pump Head Assembly

If the piston seal or self-flush seal are going to be removed, it is recommended to have a new set on hand to install after cleaning. It is not recommended to reinstall the used piston seal or self-flush seal since they are likely to be scratched and damaged during removal and would not provide a reliable seal if reused. If the seal is removed, use only the flanged end of the plastic seal removal tool supplied with the seal replacement kit. Avoid scratching the sealing surface in the pump head.

Inspect the piston seal cavity in the pump head. Remove any foreign material using a cotton swab, or equivalent, and avoid scratching the sealing surfaces. Repeat for the self-flush housing. Be sure no fibers from the cleaning swab remain in the components.

The pump head, check valves, and self-flush housing may be further cleaned using a laboratory grade detergent solution in an ultrasonic bath for at least 30 minutes, followed by rinsing for at least 10 minutes in distilled water. Be sure that all particles loosened by the above procedures have been removed from the components before re-assembly.

5.3.3 Replacing the Pump Head

Refer to figure 4-1.

1. Carefully align the self-flush housing and gently slide it into place on the pump. Make sure that the inlet valve is on the bottom and the outlet valve is on the top. If misalignment with the piston occurs, gently push up on the piston holder.
2. Install the O-ring in its groove.
3. Line up the pump head and carefully slide it into place. Be sure that the inlet valve is on the bottom and the outlet valve is on the top. Do not force the pump head into place.
4. Ensuring the lockwashers are included, finger tighten the cap screws into place. To tighten firmly, alternately turn screws 1/4 turn while gently wiggling the pump head to center it.
5. Torque the cap screws to 35 in-lbs using a suitable torque wrench and 5/32 Allen wrench adaptor.
6. Re-attach the inlet and outlet lines. Reconnect the self-flush lines. Change the flushing solution.

5.4 Piston Seals

Lower than normal pressure, pressure variations, and leaks in the pumping system can all indicate possible problems with the piston seal. Depending on the fluid or mobile phase used, piston seal replacement is often necessary after 1000 hours of running time.

Each replacement seal kit contains one seal, one backup washer, one self-flush seal, one non-flush guide bushing, two seal insertion/removal tools, and a pad to clean the piston when changing the seal.

5.4.1 Removing the Seals

1. Remove the pump head and self-flush assemblies as described in Section 4.2.1.
2. Remove the backup washer if it is present in the pump head.
3. Insert the flanged end of the seal insertion/removal tool into the seal cavity on the pump head. Tilt it slightly so that flange is under the seal and pull out the seal.



CAUTION: Using any other “tool” will scratch the finish of the sealing surface and create a leak.

4. Repeat the procedure for the low-pressure seal in the flush housing.
5. Inspect, and if necessary, clean the pump head as described in Section 4.2.2.

5.4.2 Replacing the Seals

1. Place a high-pressure replacement seal on the rod-shaped end of the seal insertion/removal tool so that the spring is visible when the seal is fully seated on the tool. Insert the tool into the pump head so that the open side of the seal enters first, facing the high-pressure cavity of the pump head. Be careful to line up the seal with the cavity while inserting. Then withdraw the tool, leaving the seal in the pump head. When looking into the pump head cavity, only the polymer portion of the seal should be visible.

2. Place a self-flush replacement seal on the seal insertion/removal tool so that the spring in the seal is visible when the seal is on the tool. As in the previous step, insert the tool and seal into the seal cavity on the flushing housing, taking care to line up the seal with the cavity, and then withdraw the tool. When the seal is fully inserted only the polymer part of the seal will be visible in the seal cavity.

NOTE: If the self-flush feature is not being used, install the provided guide bushing in place of the self-flush seal.

3. Place seal back-up washer over the high-pressure seal in the pump head.
4. Attach the pump head as described in Section 4.2.3.
5. Condition the new seal as described below.

5.4.3 Conditioning New Seals

New seals should be conditioned prior to use. Conditioning is the process of running the seals wet under controlled conditions to allow surfaces to seat and to prepare the seal for operation.

Note: Use only organic solvents to condition new seals. Buffer solutions and salt solutions should never be used to condition new seals. Recommended solvents are HPLC-grade methanol and isopropanol, and water mixtures of either.

Suggested Conditioning Parameters: Using a restrictor coil or a suitable column, run the pump with a 50:50 solution of isopropanol (or methanol) and water for 30 minutes at the back pressure and flow rate listed under PHASE 1 in the following chart and according to the pump head type. Then run the pump for another 15 minutes under conditions for PHASE 2 in the following chart, according to pump flow and pressure capabilities.

Seal Conditioning Parameters		
Flow Rate Setting	Pressure (psi) Phase 1	Pressure (psi) Phase 2
20-30% of Maximum Pump Flow	*1,000	*1,500
* - or 95% of Maximum pump capability		



Figure 4-2,
Example of polymer side vs. energizer side of seal. Note stainless steel energizer shown. Seal could have fluoropolymer o-ring energizer instead (black o-ring).

5.5 Pistons

5.5.1 *Cleaning the Piston*

1. Once the pump head and self-flush housing are removed as described in Section 4.2.1, gently remove the seal back-up plate by using either a toothpick or small screwdriver in the slot on top of the pump housing.
2. Grasp the metal base of the piston assembly so that you avoid exerting any side load on the zirconia rod, and carefully pull the piston off of the carrier.
3. Use the scouring pad included in the seal replacement kit to clean the piston. Gently squeeze the piston within a folded section of the pad and rub the pad along the length of the piston. Rotate the piston frequently to assure the entire surface is scrubbed. Do not exert pressure perpendicular to the length of the piston, as this may cause the piston to break. After scouring, use a lint-free cloth, dampened with alcohol, to wipe the piston clean.
4. Grasp the metal base of the piston assembly, and carefully reinstall it onto the carrier.
5. Place the seal back-up plate back into the pump housing.

5.5.2 *Replacing the Piston*

1. Remove the pump head as described in Section 4.2.1.
2. Gently remove the seal back-up plate by using either a toothpick or small screwdriver in the slot on top of the pump housing.
3. Grasp the metal base of the piston assembly so that you avoid exerting any side load on the zirconia rod, and remove the piston from the slot in the carrier by sliding it up.
4. Grasp the metal base of the replacement piston assembly, and carefully install it onto the carrier.
5. Place the back-up plate back into the pump housing.
6. Attach the pump head as described in Section 4.2.3.

5.6 Check Valve Cleaning and Replacement

Many check valve problems are the result of small particles interfering with the operation of the check valve. As a result, simply cleaning the pump head with the appropriate laboratory apparatus may resolve any issues.

5.6.1 *Check Valve Cleaning*

1. To clean pump check valves, remove the pump head and immerse the entire head into a laboratory ultrasonic cleaner.
 2. Sonicate for about 30 minutes using a standard cleaning solution. Rinse the pump head thoroughly with distilled water.
-
-

3. Replace the pump head assembly.
4. Run the pump at 1 mL/min (3 mL/min for a 40 mL pump head) with distilled water for fifteen minutes. Always direct the output directly to a waste beaker during cleaning (do not recycle).
5. If this procedure does not return the pump to proper performance, the check valves should be replaced. An example of new check valves from their package can be seen in Figure 4-3 below.

5.6.2 Check Valve Replacement

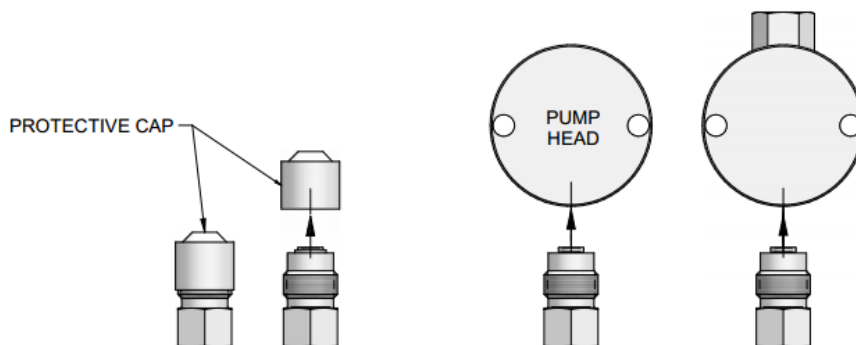

Figure 4-3, New Check Valves from package and proper orientation

1. Remove the pump head assembly.
2. Remove the check valve housings and capsules from the pump head, being careful not to scratch the sealing surfaces in the pump head. If necessary, use a seal removal tool to remove the capsules from the pump head.



CAUTION: Be careful not to break the piston when removing the pump head. Twisting the pump head can cause the piston to break.



CAUTION: Make sure check valve is kept in the above position to avoid losing parts

3. Hold one new check valve assembly as shown in *Figure 4-3* and unscrew the protective cap. With the check valve assembly maintained in the above position, thread it into the proper pump head port until it is snug. Install the other check valve assembly similarly.
4. Reinstall the pump head assembly as described in Section 4.2.3.
5. Tighten the check valve housings to 75 inch-lbs, or enough to seal at maximum pressure.
6. Reattach the solvent inlet and outlet lines.
7. Reconnect the self-flush lines to the self-flush check valves

5.6.3 Self-Flush Check Valves

Self-flush check valves can be replaced without removing the pump head of self-flush assembly, and do not require any tools. When installing new check valves, notice the outlet has a transparent washer, and the Inlet has a cross ball retainer. Also, the words INLET and OUTLET should be visible on the top of the self-flush check valves.

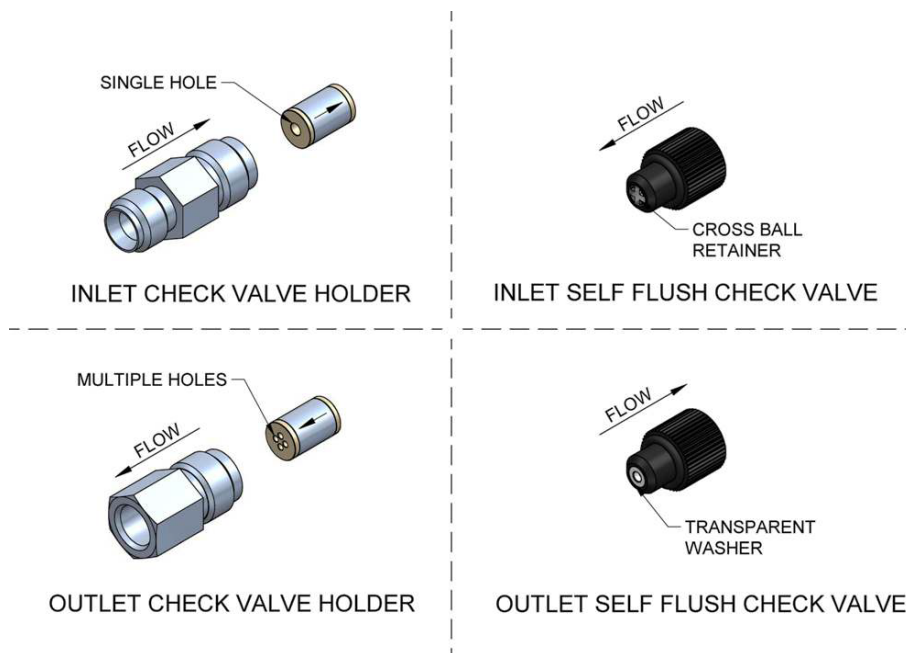

Figure 4-4, Check Valve Assemblies for Pump Head and Self-Flush Housing

5.7 Cleaning the Pump

1. Prepare the following solvents, utilizing the solvent preparation methods detailed in Section 2.4.
 - a. 100% isopropanol
 - b. 100% filtered, distilled water
 - c. 20% nitric acid/water solution.
2. Direct the pump outlet line to a waste beaker.
3. Set the flow rate to 150 mL.
4. Pump 100% isopropanol through the pump for 3 minutes.
5. Pump 100% filtered, distilled water through the pump for 3 minutes.



WARNING: Use standard laboratory procedures and extreme care when handling strong acids and bases.

6. Pump a 20% nitric acid/water solution through the pump for 3 minutes.
7. Flush the pump with 100% filtered, distilled water for at least 3 minutes.

8. Pump 100% isopropanol through the pump for 3 minutes.

The pump is now prepared for any mobile phase or short- or long-term shutdown.

5.7.1 *Cleaning the cabinet*

Cabinet may be cleaned with tap water or a mild soap solution.

5.8 Lubrication

The HF model pump has modest lubrication requirements. The bearings in the pump housing and piston carrier are permanently lubricated and require no maintenance. A small dab of a light grease such as Lubriplate 630-AA on the cam is the only recommended lubrication. Be sure not to get lubricant on the body of the piston carrier, as this can retard its movement and interfere with proper pumping.

Note: Keeping the interior of the pump free of dirt and dust will extend the pump's useful life.

5.9 Fuse Replacement

The HF Series Pump is protected by two fuses, located inside the power entry module at the rear of the cabinet, in series with the AC input line.

Troubleshooting the fuses is straightforward. With the power cord connected and the master power switch ON, if the rear case fan does not run, check the two fuses in the power entry module. To gain access to these fuses, gently pry off the cover plate with a small flat-bladed screwdriver. Replace with fuses of the same rating.

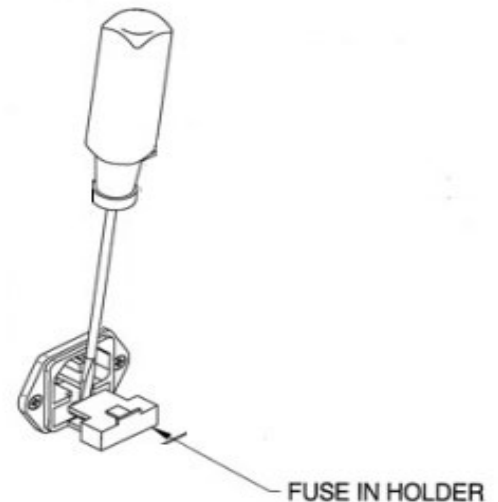

Figure 4-5, Fuse Replacement

6 QUICK GUIDE TO PROBLEM SOLVING

You Notice	This May Mean	Possible Cause	You Should
<ol style="list-style-type: none"> 1. Uneven pressure trace. 2. Pressure drops. 3. Pump shuts OFF. 4. No flow out the outlet check valve. 	<ol style="list-style-type: none"> 1. Bubble in check valve. 2. Leaks in system. 3. Dirty check valve. 4. Bad check valve. 	<ol style="list-style-type: none"> 1. Solvent not properly degassed. 2. Fittings are not tight. 3. Mobile phase not properly filtered. 4. Particles from worn piston seal caught in check valve. 5. Plugged inlet. 	<ol style="list-style-type: none"> 1. Check to be certain that mobile phase is properly degassed. 2. Check connections for leaks by tightening fittings. 3. Prime the system directly from the outlet check valve. 4. Clean or replace the check valves. See Section 4.4. 5. Clean or replace inlet. See Section 4.1.1.
<ol style="list-style-type: none"> 1. Uneven pressure trace. 2. Pressure drops. 3. Fluid between the pump head and the chassis. 	<ol style="list-style-type: none"> 1. Leaks in system. 2. The piston seal(s) are worn. 	<ol style="list-style-type: none"> 1. Fittings not tight. 2. Long usage time since last seal change. 3. Salt deposits on seal (especially if buffered aqueous mobile phases are used without the self-flush head.) 	<ol style="list-style-type: none"> 1. Check all connections for leaks. 2. Replace piston seal. See Sections 4.2 and 4.3. 3. Check the piston for salt deposits. Clean as necessary. See Section 4.2.5.
<p>Pump makes a loud clanging or slapping noise (intermittent contact with cam).</p>	<p>Piston carrier is catching in piston guide.</p>	<ol style="list-style-type: none"> 1. Cap nut screws on the pump head are loose. 2. Seal(s) are worn. 3. Piston guide is worn 4. Salt build-up on piston carrier from use of buffers. 5. Excess lubricant on piston carrier. 	<ol style="list-style-type: none"> 1. Check cap nut screws on pump head. Tighten if necessary. 2. Replace seals. 3. Replace piston guide and seals. See Sections 4.2 and 4.3. 4. Consider changing to a self-flushing pump head if using buffers. 5. Clean excess lubricant and dirt off piston carrier. See Section 4.7.
<p>Pump runs for 50 pump strokes, and then shuts down.</p>	<p>Lower pressure limit is activating.</p>	<ol style="list-style-type: none"> 1. Mobile phase is not properly filtered. 2. Particles from worn seal trapped in the system (e.g., tubing, filters, injection valve, column inlet). 	<ol style="list-style-type: none"> 1. Check to be certain the low-pressure limit is set to 0 psi. 2. Only increase the low-pressure limit after the pump attains operating pressure. 3. Contact service technician.
<ol style="list-style-type: none"> 1. Pump shuts down after run is called even with no column connected. 2. Pump runs to maximum pressure and shuts down. 	<p>Clog in fluid system.</p>		<ol style="list-style-type: none"> 1. Remove and clean the bulkhead outlet filter. See Section 4.1. 2. If the problem persists, remove tubing from system one piece at a time until you find the clogged piece. Most clogs occur outside the pump itself.
<p>No power when pump turned ON. Fan does not run.</p>	<p>Blown fuses in the power entry module.</p>	<ol style="list-style-type: none"> 1. Power surge. 2. Internal short. 	<ol style="list-style-type: none"> 1. Replace only with the appropriate fuses 10A 250Vac. 2. Contact service technician if problem persists.
<p>Front panel appears OK but pump motor does not run.</p>		<ol style="list-style-type: none"> 1. Power surge. 2. Internal Servo Control Board error. 	<ol style="list-style-type: none"> 1. Replace only with the appropriate fuse. 2. Contact service technician if problem persists.

7 WARRANTY STATEMENT

Teledyne SSI (SSI) warrants that instruments or equipment manufactured by the company for a period thirty-six (36) months from date of shipment to the original purchaser (or to the drop ship location as indicated on the Purchase Order from the original purchaser), against defects in materials and workmanship under normal installation, use and maintenance. Products sold by SSI but not manufactured by SSI carry the Original Manufacturer's Warranty, beginning as of the date of shipment to SSI's original purchaser. Expendable items and physical damage caused by improper handling or damage caused by spillage or exposure to any corrosive environment are excluded from this warranty. The warranty shall be void for Polyetheretherketone (PEEK) components exposed to concentrated Nitric or Sulfuric acids which attack PEEK, or methylene chloride, DMSO or THF which adversely affect UHMWPE seals and PEEK tubing. Any defects covered by this warranty shall be corrected by replacing or repairing, at SSI's option, parts determined by SSI to be defective.

Spare or replacement parts and accessories shall be warranted for a period of twelve (12) months from date of shipment to the original purchaser against defects in materials and workmanship under normal installation, use and maintenance. Defective Product will be accepted for return to SSI only if the request for return is made within thirty (30) days from the time of discovery of the alleged defect, and prior to return, the original purchaser obtains a Return Goods Authorization (RGA) number from SSI, and provides SSI with the serial number of each instrument to be returned.

The warranty shall not apply to any Product that has been repaired or altered except by SSI or those specifically authorized by SSI, to the extent that such repair or alteration caused the failure, or to Product that has been subjected to misuse, negligence, accident, excessive wear, or other causes not arising out of a defect in material or workmanship.

The warranty shall not apply to wear items, specifically:

- Check Valves
- Piston and Wash Seals
- Pistons
- Pulse-Damper Diaphragms
- Inlet Lines
- Filter Elements

The following is the exclusive procedure by which to make claims under this warranty. Customer shall obtain SSI's oral or written authorization to return the Product and receive a Return Goods Authorization (RGA) number. The Product must be returned with the RGA number plainly visible on the outside of the shipping container to SSI. It must be securely packed in a rigid container with ample cushioning material, preferably the original packaging. All claimed defects must be specified in writing, including the RGA number, with the written claim accompanying the Product. Freight costs for the return of reported defective Product from the original purchaser to SSI is the responsibility of the original purchaser. Freight costs for the return of reported defective spare parts is the responsibility of SSI. SSI shall specify the freight carrier for returns. SSI shall bear the expense of return shipment to original purchaser (or to the drop ship location as indicated on the Purchase Order from the original purchaser).

If it appears to SSI that any Product has been subjected to misuse, negligence, accident or excessive wear, or is beyond the warranty period, the original purchaser and/or customer shall be notified promptly. SSI shall communicate its finding and provide an estimate to repair such Product at the then current rates for parts and service. SSI shall either repair the Product per customer's authorization or shall return such Product not repaired to customer at customer's expense. SSI may invoice customer for the freight costs of any Product shipped back to the original purchaser and/or customer by SSI which is not covered under the warranty.

Limitations of Warranty. THE FOREGOING WARRANTIES AND LIMITATIONS ARE CUSTOMER'S EXCLUSIVE REMEDIES AND ARE IN LIEU OF ALL OTHER WARRANTIES, EXPRESS OR IMPLIED, INCLUDING WITHOUT LIMITATION ANY WARRANTY OF MERCHANTABILITY OR FITNESS FOR A PARTICULAR PURPOSE.

8 COMPANY CONTACT INFORMATION

[Teledyne SSI](#)

349 Science Park Road
State College, PA 16803

800-441-HPLC (4752)

Technical Support: 814-234-7311

Sales: Option 2

Technical & Service Support: Option 3