

CP-Class Pump

Dual Piston Constant Pressure Pumps for Column Packing and Process Applications



Operator Manual

903042Rx REV B



Teledyne SSI 349 N. Science Park Road State College, PA 16803
<https://ssihplc.com> Phone: 814-234-7311 Fax: 814-238-7532
Email: ssi_sales@teledyne.com

Use and Disclosure of Data Information contained herein is classified as EAR99 under the U.S. Export Administration Regulations.
Export, reexport or diversion contrary to U.S. law is prohibited.

Warning Symbols and Task Specific Hazard Warnings:

The following warning symbols are present to alert you to risks that can arise when you install, operate or maintain the CP-Class pump. Such risks include chemical exposure, electric shocks, and others.

When the following symbols appear in the manual, as well as words such as “**CAUTION**, **NOTE**, or **WARNING**,” their accompanying text identifies the specific risks and explains how to avoid them. Teledyne SSI assumes no liability for the misuse of the information described in this manual in regards to installation, repair, or operation of the CP-Class pump and its components.

SAFETY SYMBOLS



CAUTION – HIGH VOLTAGE



CAUTION – REFER TO MANUAL



EARTH GROUND

SYMBOLES DE SÉCURITÉ



ATTENTION – HAUTE TENSION



ATTENTION – SE REPORTER AU MANUEL



TERRE



Teledyne SSI 349 N. Science Park Road State College, PA 16803
<https://ssihplc.com> Phone: 814-234-7311 Fax: 814-238-7532
Email: ssi_sales@teledyne.com

TABLE OF CONTENTS

1. Introduction	4
Description of the CP-Class Pump	4
Pump Features	4
Wetted Materials	4
Long Term Pressure Calibration Accuracy	4
Self-Flushing Pump Head	5
Recommended Use of Self-Flush Feature	5
Flush Conversion Procedure	7
2. Quick Startup Guide	9
3. Installation	10
Unpacking and Inspection	10
Location/Environment	10
Electrical Connections	10
Drip Tray	10
Solvent Preparation	10
Solvent Out-gassing and Sparging	10
Cavitation	11
Filtration	11
Solvents with Harmful Effects	11
Instrument Installation	12
Mobile Phase Reservoirs	12
Self-Flush Solution	12
Inlet Tubing and Filters	12
Outlet Tubing	12
Priming the Pump and the Flushing Lines	12
Preparation for Storage or Shipping	13
Isopropanol Flush	13
Packaging for Shipping	13
4. Operation	14
Front Panel Controls and Indicators	14
Prime/Purge Valve	14
Filter/Outlet	14
Digital Display	15
Keypad	15
Status LEDs	16
Menu Screens	16
Leak Sensor	17
Power-Up Configuration	17

Non-volatile Memory Reset.....	19
Rear Panel Remote Input.....	20
5. Maintenance	21
Recommended Spare Parts Lists	21
Filter Replacement.....	21
Inlet Filters	21
Outlet Filter	21
Pump Head Assemblies	22
Removing the Pump Head Assembly	22
Cleaning the Pump Head Assembly	25
Replacing the Pump Head	25
Piston Seals.....	25
Removing the Seals.....	25
Replacing the Seals.....	26
Conditioning New Seals.....	26
Pistons	27
Cleaning the Piston.....	27
Replacing the Piston	27
Check Valve Cleaning and Replacement	27
Check Valve Cleaning.....	27
Check Valve Replacement.....	28
Self-Flush Check Valves.....	29
Cleaning the Pump.....	30
Lubrication	31
Fuse Replacement	31
Fitting Adapter Kits.....	32
<i>For Stainless Steel Fluid Path Models</i>	<i>32</i>
To convert the inlet connection	32
<i>For Hastelloy Fluid Path Models:</i>	<i>34</i>
6. Quick Guide to Problem Solving.....	36
7. Appendix A	37
Rear Panel Serial Communications Port.....	37
Hardware Implementation.....	37
Command Interpreter.....	37
Pump Command List	38
Rear Panel 10-Pin Terminal Board Connector.....	46
Relay Output.....	46
General Information on Run, Stop, and Enable Inputs.....	46
Run and Stop Inputs	46
Analog Input Source	47

Analog Input Enable.....	47
Voltage Input.....	47
Current Input.....	47
Fault Output.....	47
8. Appendix B	48
Specifications for the CP-Class Pump, 5 mL/min	48
Specifications for the CP-Class Pump, 12 mL/min, 18,000 psi	48
Specifications for the CP-Class Pump, 24 mL/min	49
Specifications for the CP-Class Pump, 100 mL/min	49
9. Warranty Statement	50
10. Company Contact Information	51



1. INTRODUCTION

This operator's manual contains information needed to install, operate, and perform minor maintenance on the CP-Class Pump.

Description of the CP-Class Pump

The CP-Class pump is designed for constant pressure applications up to 25,000 psi. It is also suitable for many column packing or process applications.

For pump specific information and specifications, please refer to Appendix B.

Pump Features

- The CP-Class Pump includes:
- Automatic pump shut-off if the pressure exceeds the maximum pressure limit
- User settable upper and lower pressure limits
- Constant Pressure mode with user settable pressure set point
- Integrated prime/purge valve
- Outlet Filter
- 5-digit LED front panel user keypad
- PRIME mode to flush out entrapped air bubbles upon start-up
- Back panel RS-232, USB and Ethernet communication ports for complete control and status
- Remote analog input to control flow rate (0-10V or 4-20mA)
- Remote digital inputs for pump control, outputs for fault indication
- Digital stepper motor design
- Drip tray with leak sensor
- CP-class pumps are built in the no-flush configuration, with a flush conversion kit included

Wetted Materials

Pump heads, check valve bodies, and tubing are made out of type 316 stainless steel or Hastelloy. Other common are synthetic ruby and sapphire (check valves and pistons), ATZ (5mL check valves), Silicon carbide (5mL piston), Zirconia (100mL piston) UHMWPE (seals), ETFE (check valves), PTFE (filter gasket), PEEK (filter gasket, 5mL and 12mL check valves), FFKM (transducer o-ring), PFA (pulse damper - only present on 24mL JKHA).

Long Term Pressure Calibration Accuracy

The pump is equipped with an electronic pressure transducer. The transducer has been zeroed and calibrated at the factory. Over the life of the pump, some drift may occur.

If pressure calibration and/or drift are a concern, consult the factory.

Self-Flushing Pump Head

Self-flushing pump heads provide continuous washing of the piston surface without the inconvenience of a manual flush or gravity feed arrangement. The self-flushing pump head uses a self-flush seal and secondary set of check valves to create a continuous and positive flow in the area behind the high-pressure pump seal. The flushing solution washes away any buffer salts that have precipitated onto the piston. If not removed, these precipitates can abrade the high-pressure seal and cause premature seal failure, leakage, and can possibly damage the pump.

Note: Pump does not include Self-Flush in the as-built configuration

Recommended Use of Self-Flush Feature

It is **strongly** recommended that the Self Flush feature be used to improve seal life in a number of applications. In particular, (as stated above) if pumping Buffers, Acids/Bases or any inorganic solution near saturation, the pump must utilize the Self Flush feature. With every piston stroke, an extremely thin film of solution is pulled back past the seal. If this zone is dry (without use of Self Flush) then crystals will form during continuous operation, which will ultimately damage the seal.

Another application where Self Flush is highly recommended is when pumping Tetrahydrofuran (a.k.a. THF, Diethylene Oxide) or other volatile solvents such as acetone (Note: THF and most solvents are compatible only with all-Stainless Steel systems. THF will attack PEEK). Volatile solvents will dry rapidly behind the seal (without the use of Self Flush), which will dry and degrade the seal.

Solutions of either 100% IPA, 100% Methanol, 20% IPA/water mix, or 20% Methanol/water mix are the specified self-flush solutions are recommended. Consult factory if these are unacceptable for the application. Do not use only water for the self-flush solution (e.g. DI water, tap water, filtered water), as water alone can cause abrasion of the high-pressure piston seal, as well as the self-flush seal. If there is any doubt about which self-flush solution to use, please consult the factory.

Refer to Figure 1, on the next page, for detailed drawing of a self-flushing pump head.

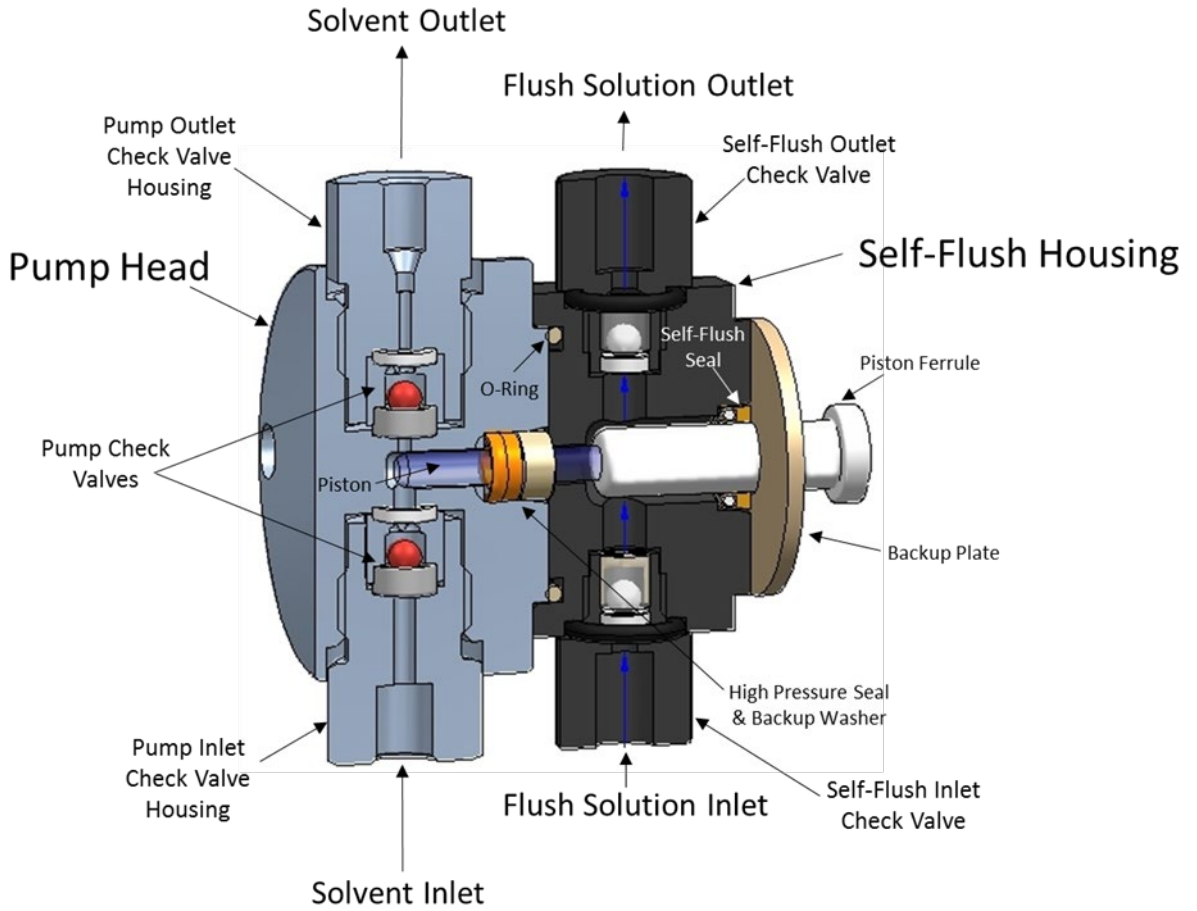

(May not represent exactly what is installed in the purchased pump.)

PUMP MODIFICATION IF SELF-FLUSH IS USED

If the self-flush feature is desired, the pump must be converted from its as-built non-flushing configuration, according to the instructions on the next page.

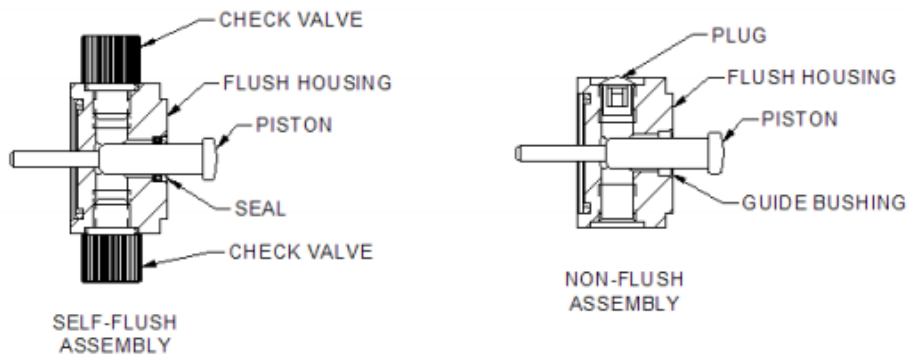

Flush Conversion Procedure

Note: The conditioning of the seals may be required if the pump sits too long after the conversion. Conditioning is covered in 3.0.

1. Using a hex tool, remove the two hex head fasteners.

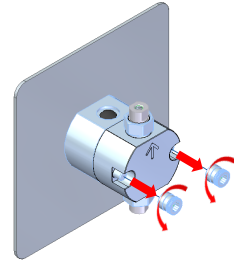

2. Carefully pull the pump head forward and off the guide pins. Keep the self-flush in place. Pull straight and slowly to prevent damage to the piston. **Note:** the back-up washer may remain on the piston. Carefully remove it and install when reassembling.

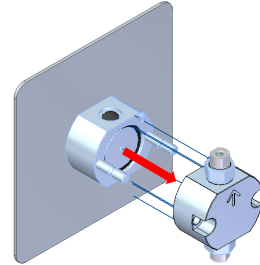

3. Carefully pull the flush housing forward and off the guide pins. Pull straight and slowly to prevent damage to the piston. **Note:** assure that the "O"-ring remains in the flush housing.

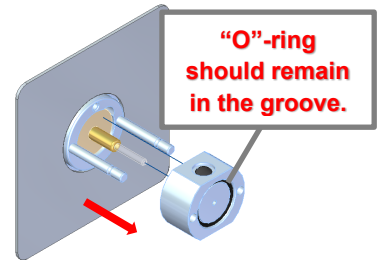

4. Using the supplied seal tool, remove the guide bushing in the direction shown. The outlet port hole plug can also be removed at this time.

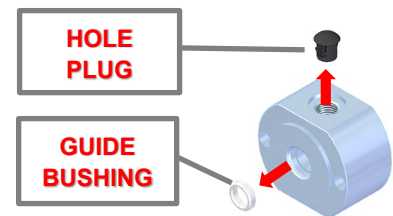

5. Identify the inlet and outlet check valve assemblies supplied in the conversion kit.

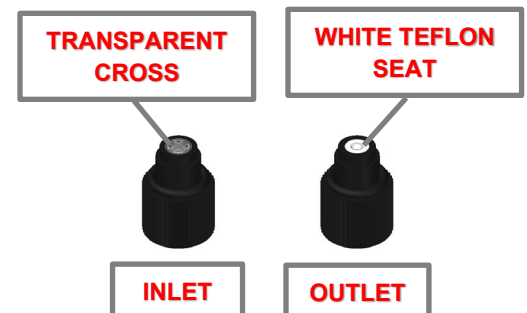

6. Install the inlet and outlet check valve assemblies into the self-flush housing in the proper orientation. Tighten hand tight. A quarter turn with pliers may be required to seal.

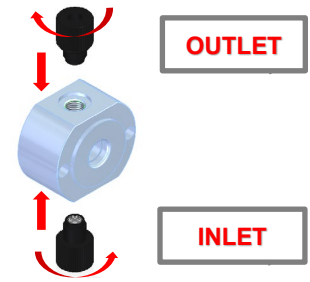

7. Slide the self-flush seal from the conversion kit, onto the provided seal tool (Note - Stainless Steel energizer spring of seal to face the seal gland when installing). Install the self-flush seal into the self-flush housing seal gland using the seal tool provided.

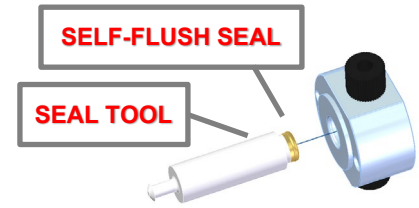

8. Carefully slide the self-flush assembly onto the guide pins, making sure the piston is aligned with the center hole of the self-flush housing.

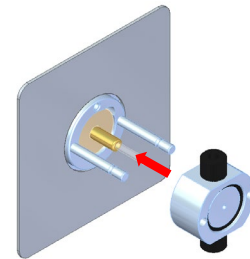

9. Carefully slide the back-up washer onto the piston, in front of the wash housing. Then, carefully slide the pump head into place. Push onto guide pins straight and slowly to prevent damage to the piston.

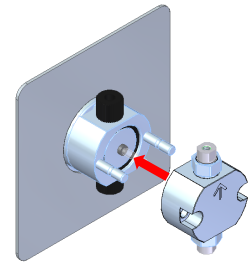

10. Using a hex tool, reinstall fasteners. As you tighten, alternate side-to-side until snug. Turn 1 flat past snug.

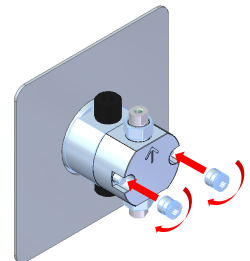

2. QUICK STARTUP GUIDE



CAUTION: Always release pressure from the pump slowly. A rapid pressure release could cause the pulse dampener diaphragm to rupture. Please refer to “Priming the Pump and Flush Line” for more information.

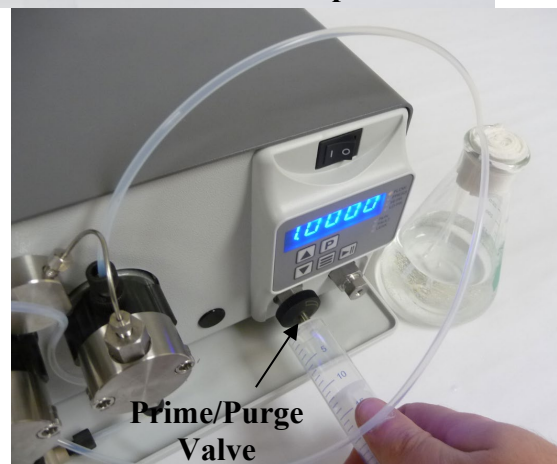
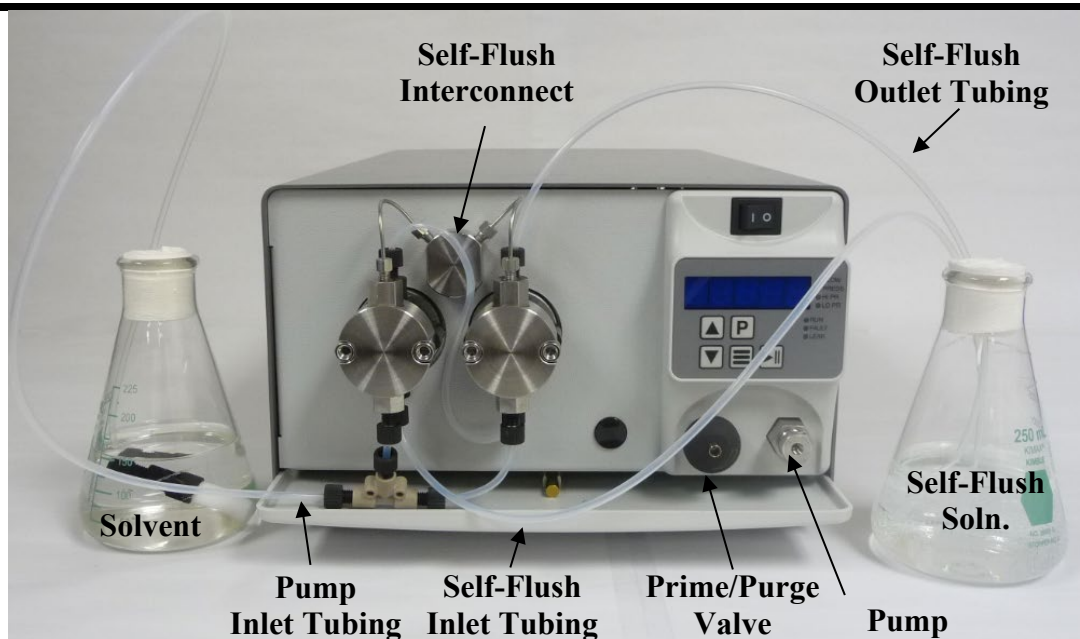

Self-Flush

- Connect self-flush solution **inlet** tubing to the **bottom-left** self-flush check valve, and the **outlet** tubing to the **top-right** self-flush check valve as shown.

Note: The self-flush housings are interconnected at the factory for flow-through with a single inlet/outlet.

- Attach syringe to outlet self-flush tubing.
- Draw syringe back to prime.
- After liquid has been pulled through the tubing into the syringe, remove syringe and place tubing in self-flush solution.

**Replace self-flush solution weekly.*

Note: If the self-flush feature is not used, please refer to page 3 for necessary pump modification.

Pump

- Connect pump inlet tubing to bottom of both pump heads as shown. *Make sure ferrule is in the correct position.*
- Attach syringe to Prime / Purge valve.
- Open Prime / Purge valve by turning knob counterclockwise one to two turns.
- Draw syringe back to prime. *Draw approximately 20 mL of fluid.*
- Press PRIME button (P), continue to draw on syringe until no bubbles are seen.
- Close Prime / Purge valve.
- Press PRIME button (P).
- Remove syringe.

** Replace solvent weekly.*

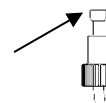

3. INSTALLATION

Unpacking and Inspection

Prior to opening the shipping container, inspect it for damage or evidence of mishandling. If it has been damaged or mishandled, notify the carrier before opening the container. Once the container is opened, inspect the contents for damage. Any damage should be reported to the carrier immediately. Save the shipping container. Check the contents against the packing list.

Location/Environment

The instrument must be located on a stable flat surface with at least a four inch clearance on all sides for proper ventilation and the necessary electrical and fluid connections. The acceptable environment for the CP-Class pump is normal indoor laboratory conditions and must adhere to pollution degree 2. The installation altitude shall not exceed 2,000 meters. The area must be clean and have a stable temperature and humidity. The specific temperature and humidity conditions are 10 to 30 °C and 20% to 90% relative humidity.

Electrical Connections

Using the power cord supplied with the pump, or equivalent, plug the pump into a properly grounded electrical outlet. Acceptable input power is 100 – 240 VAC, 50/60 Hz. Voltage fluctuations must not exceed $\pm 10\%$ of the nominal supply voltage.



WARNING: Do not bypass the safety ground connection as a serious shock hazard could result.

Drip Tray

The drip tray is included in the box, shipped loose. Slide it into its slot towards the bottom of the pump until it is fully installed. The pump is supplied with a leak sensor, install this into the slot provided. Please note that the leak sensor is connected to the control board within the pump, so do not attempt to completely remove this from the pump unless it is first disconnected from the board.

Solvent Preparation

Proper solvent preparation will prevent a great number of pumping problems. The most common problem is bubble formation, which may affect the flow rate consistency. Aside from leaky fittings, the problem of bubble formation arises from two sources: solvent out-gassing and cavitation. Filtration of HPLC solvents is also required.

Solvent Out-gassing and Sparging

Solvent out-gassing occurs because the mobile phase contains dissolved atmospheric gases, primarily N₂ and O₂. These dissolved gases may lead to bubble formation and should be removed by degassing the mobile phase before or during use. The best practical technique for degassing is to sparge the solvent with standard laboratory grade (99.9+ %) helium. Helium is only sparingly soluble in HPLC solvents, so other gases dissolved in the solvent diffuse into the helium bubbles and are swept from the system. Solvent filtration is not an effective alternative to helium degassing.

It is recommended to sparge the solvent vigorously for 10 to 15 minutes before using it. Then maintain a trickle sparge during use to keep atmospheric gases from dissolving back into the mobile phase. The sparged solvent must be continually blanketed with helium at 2 to 3 psi. Non-blanketed, sparged solvents will allow atmospheric gases to dissolve back into the mobile phase within four hours.

Solvent mixtures using water and organic solvents (like methanol or acetonitrile) hold less dissolved gas than pure solvents. Sparging to reduce the amount of dissolved gas is therefore particularly important when utilizing solvent mixture.

Even with sparging, some out-gassing may occur. A back pressure regulator installed after the detector flow cell will help prevent bubbles from forming and thus limit baseline noise.

Cavitation

Cavitation occurs when inlet conditions restrict the flow of solvent and vapor bubbles are formed during the inlet stroke. The key to preventing cavitation is to reduce inlet restrictions. The most common causes of inlet restrictions are crimped inlet lines and plugged inlet filters. Inlet lines with tubing longer than 48" (120 cm) or with tubing of less than 0.085" (2 mm) ID may also cause cavitation.

Placing the solvent reservoirs below the pump level also promotes cavitation. The optimal location of the reservoirs is slightly above the pump level, but it is adequate to have them on the same level as the pump.

Filtration

Solvent filtration is good practice for the reliability of the CP-Class pump and other components in the system. Solvents should always be filtered with a 20 micron filter prior to use. This ensures that no particles will interfere with the reliable operation of the piston seals and check valves. Solvents in which buffers or other salts readily precipitate out will need to be filtered more often. After filtration, the solvents should be stored in a closed, particulate-free bottle.

Solvents with Harmful Effects



Except for Hastelloy fluid paths, all portions of the CP-Class pump that contact mobile phase are manufactured of type 316 stainless steel, ceramic, sapphire, ruby, PEEK, or fluoropolymers. Some of these materials are extremely sensitive to acids (including some Lewis acids) and acid halides. Avoid using solvents that contain any amount of hydrochloric acid.

Some solvents to specifically avoid are:

Aqua Regia	Hydrochloric Acid
Bromine	Hydrofluoric Acid
Chlorine Anhydrous	Hydrofluorsilicic Acid
Copper Chloride	Hydrogen Peroxide
Ferric Chloride	Iodine
Ferrous Chloride	Mercuric Chloride
Freon 12 (wet)	Guanidine
Hydrobromic Acid	

In addition, some users of HPLC systems have observed that chloroform and carbon tetrachloride slowly decompose to liberate hydrochloric acid, which, as noted above, attacks stainless steel. Do not leave these solvents in the systems for a prolonged period.

It is also recommended to avoid ammonium hydroxide. Although ammonium hydroxide will not harm the pump itself, it is likely to damage the stator and rotor in injection valves.

Instrument Installation

Mobile Phase Reservoirs

The mobile phase reservoir should be placed at the same level or slightly higher than the pump, never below the pump, and the inlet tubing should be as short as practical. These steps minimize pressure losses on the inlet side of the pump during refill and help to avoid bubble formation. These steps are particularly important when using high vapor pressure solvents (hexane, methylene chloride, etc.). Mobile phases should be degassed, filtered and covered.

Self-Flush Solution

If the Self-Flush feature is being used, prepare a 250-500 mL self-flush solution of either 100% IPA, 100% Methanol, 20% IPA/water mix, or 20% Methanol/water mix. This solution should be replaced with a fresh solution weekly to avoid frequent pump maintenance. If there is any doubt about which self-flush solution to use, please consult the factory.

Inlet Tubing and Filters

Inlet tubing is supplied with the pump startup kit, has a 0.085" ID, a 1/8" OD, and is made of a Teflon-based material. Use the 20 micron filter supplied with the pump.

Outlet Tubing

Outlet tubing (not supplied with the pump) should be compatible with the 10-32 cone fitting for 1/16" O.D. tubing, or if using the outlet tubing adapter kit (24 and 100 mL only, pages 33 & 34) 1/8" external CPI for 1/8" rigid tubing. The tubing must be cut squarely and with no burrs. The tube itself should not be crimped and the center hole must be open. A tubing cutter is recommended for cutting stainless steel tubing.

Priming the Pump and the Flushing Lines

Be sure all of the connections downstream of the prime/purge valve are closed. Connect a syringe to the priming valve. Open the prime/purge valve 1 to 2 turns (counter-clockwise). Prime the pump by pulling mobile phase and any air bubbles through the system and into the syringe (a minimum of 20 mL). Press the Prime button and continue to draw on the syringe until no bubbles are seen. Close the prime/purge valve. Press the Prime button and remove the syringe. Be sure to replace solvent weekly.

To prime the flush lines for a self-flush head, simply place the inlet line in the flush solution and connect a syringe to the outlet line and apply suction until the line is filled with flush solution. Place the outlet line in the flush solution. Secure both flush lines in the flush solution container so they stay immersed during pump operation. Be sure to replace the self-flush solution weekly.

Note: If the self-flush option is used, see Figure 1 for proper pump modification.

Please refer to the Quick Startup Guide for more information.

Preparation for Storage or Shipping

Isopropanol Flush

Disconnect the outlet tubing from the pump. Place the inlet filter in isopropanol. Use a syringe to draw a minimum of 50 ml through the pump. Pump a minimum of 5 ml of isopropanol to exit. Leave the inlet tubing connected to the pump. Place the inlet filter in a small plastic bag and attach it to the tubing with a rubber band. Plug the outlet port with the shipping plug or leave a length of outlet tubing on the pump or cover the outlet port with plastic film.

Packaging for Shipping

Reship in the original carton, if possible. If the original carton is not available, wrap the pump in several layers of bubble wrap and cushion the bottom, top, and all four sides with 2" of packaging foam.



CAUTION: Although heavy, this pump is a delicate instrument and must be carefully packaged to withstand the shocks and vibration of shipment.

4. OPERATION

Front Panel Controls and Indicators

Refer to Figure 2 for pump front panel components.

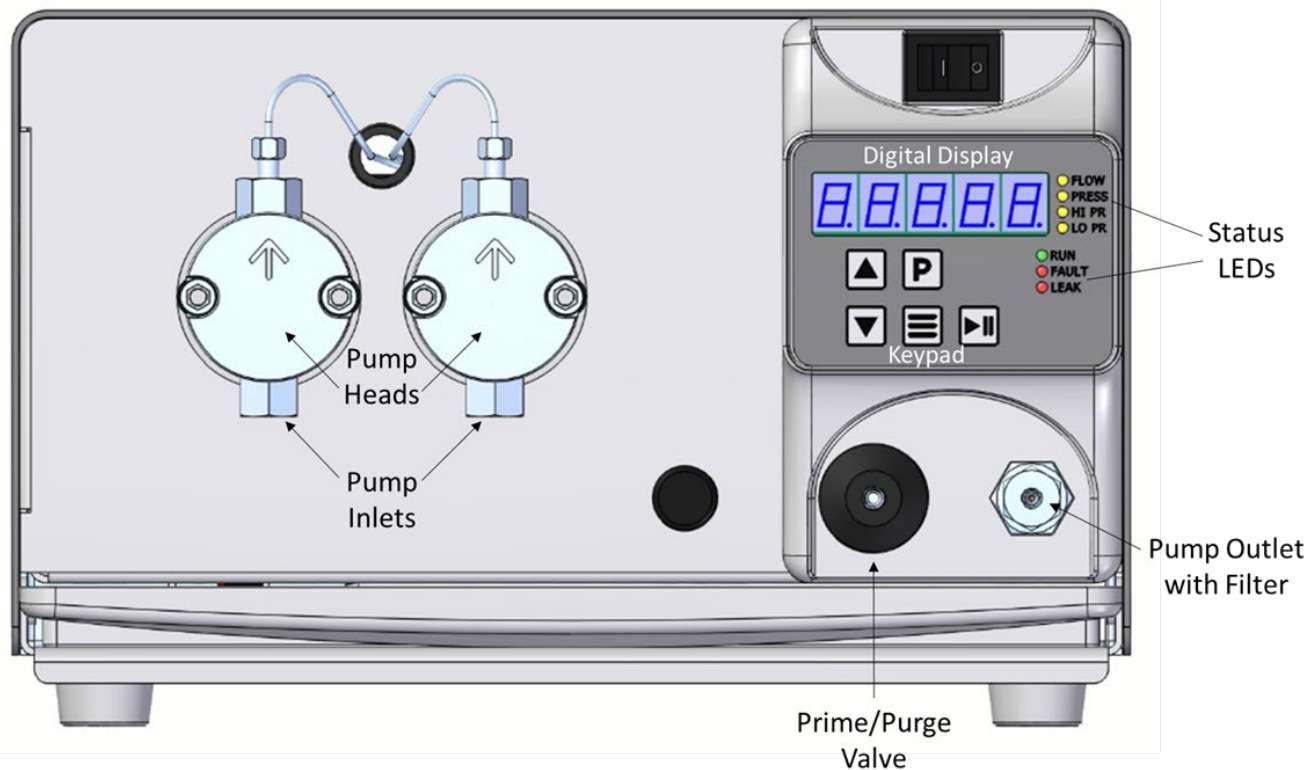

Figure 2, CP-Class Pump Front Panel Components

Prime/Purge Valve



CAUTION: When the PRIME button (P) is pressed, the pump will run at the maximum flow rate. Be sure the prime/purge valve is open.

The prime/purge valve vents the flow to atmosphere and permits efficient priming of the CP-Class pump. When the valve is closed (fully clock-wise), high-pressure flow is directed to the Filter/Outlet port. When the valve is opened (counter clock-wise), pressure is vented and flow exits through the drain port in the prime/purge valve stem assembly. Suction with a Luer tip syringe at the drain port will purge air bubbles from the pump and reservoir lines (provided there are no open valves to lines down-stream at the injector/column interface). To prime the pump, draw about 20 to 30 mL of mobile phase.

Filter/Outlet

A high-pressure in-line filter (0.5 micron on 5 mL and 12 mL pumps, 2 micron on 24 nL and 100 mL pumps) is included at the output of the CP-Class pump. The Filter/Outlet port is the high pressure filter closure as supplied, is designed for 1/16" OD tubing connection. Other outlet connections available (24 and 100 mL only), reference pages 33 & 34 for adapter fitting options.

Digital Display

The 5-digit display shows the pump flow rate set point (mL/min), current flow rate (maximum allowable flow rate, mL/min), constant pressure set point (psi, or MPa), current system pressure (psi, or MPa), upper pressure limit (psi), or lower pressure limit (psi). Choice of display is selected with the MODE key.

Keypad



RUN/STOP button - alternately starts and stops the pump.



UP-ARROW button - increases the displayed parameter.



DOWN-ARROW button - decreases the displayed parameter.



PRIME button – the pump will run at a flow rate suitable for priming the pump. To exit prime mode, either press the PRIME button again, or press the RUN/STOP button.



MODE button - cycles through the six display modes: flow rate set point (maximum allowable flow rate), current flow rate, constant pressure set point, current pressure, upper pressure limit, or lower pressure limit. A status LED to the right of the digital display indicates which mode is active. A solid LED indicates display of a set point; a blinking LED indicates display of the current flow rate or pressure.

Fast and Slow Button Repeat:

If the UP-ARROW or DOWN-ARROW button is held down for more than approximately one half of a second, the button press will repeat at a slow rate. Once slow button repeat has begun, fast button repeat can be initiated by using a second finger to press down the second arrow button. Switching back and forth between repeat speeds can be accomplished by pressing and releasing the second arrow button while keeping the first arrow button held down.

Status LEDs

FLOW	When lit (solid), the display shows flow rate set point in mL/min.
FLOW	When blinking, the display shows current flow rate in mL/min.
PRESS	When lit (solid), the display shows constant pressure set point in psi, or MPa.
PRESS	When blinking, the display shows current system pressure in psi, or MPa.
HI PR	When lit, the display shows the user-set upper pressure limit in psi, or MPa.
LO PR	When lit, the display shows the user-set lower pressure limit in psi, or MPa.
RUN	When lit, this indicates that the pump is running.
FAULT	When lit, a pressure or leak fault has occurred.
LEAK	When lit, a leak has been detected.

Menu Screens

Flow Rate Set Point / Maximum Flow Rate

Displays the maximum allowable flow rate in mL/min. The CP-Class pump will vary the flow rate up to this value in order to maintain a steady operating pressure. This value may be adjusted by using the up and down arrow keys, or the appropriate serial commands.

Flow Rate Readout

Displays the current flow rate in mL/min.

Constant Pressure Set Point

Displays the constant pressure mode target pressure. The CP-Class pump will vary the flow rate in order to maintain this value. This value may be adjusted by using the up and down arrow keys, or the appropriate serial commands. Refer to the Constant Pressure Command section in Appendix A for a list of commands used to tune the PID algorithm used for Constant Pressure control. Refer to the Power-Up Configuration section below for configuring the PID from the front keypad display.

Pressure Readout

Displays the current system pressure in psi, as read by a pressure sensor within the pump cabinet.

Upper Pressure Limit

Displays the upper pressure limit for the pump. This value may be adjusted by using the up and down arrow keys, or the appropriate serial commands. When the system pressure exceeds the upper pressure limit, an upper pressure fault will be triggered, and the pump will stop. In some cases, there may be a small amount of headroom between the upper pressure limit and the system pressure which actually triggers the fault, which may cause the fault to appear to be delayed. In these cases, it may be advantageous to set the limit to a slightly lower value.

Lower Pressure Limit

Displays the lower pressure limit for the pump. This value may be adjusted by using the up and down arrow keys, or the appropriate serial commands. When the system pressure is below the lower pressure limit, a lower pressure fault will be triggered, and the pump will stop. There is a delay between the start of the pump and the monitoring of the pressure for the low pressure fault. This delay is typically 20 pump strokes.

Leak Sensor

The leak sensor will monitor the drip tray for the presence of leaking solvent. If a leak is detected, the **LEAK** LED will illuminate. As default mode, the presence of a leak will not trigger a pump fault or cause the pump to stop.

The Leak Mode can be altered with the **LMx** serial command (Appendix A) so that the presence of a leak will trigger a pump fault and cause the pump to stop and display “**driP**.” This condition will persist until the drip tray is free of solvent and the leak sensor has been dried. Once cleaned, pressing the **RUN/STOP** button or issuing the appropriate serial command will restore normal pump operation.



NOTE: The leak sensor technology is temperature dependent and may cease to function properly outside normal operating temperatures. With each power-up of the pump, the leak sensor is inactive for a period of 5 minutes to allow for circuit equilibration. Normal operation will begin following equilibration.

Power-Up Configuration

On power-up, press and hold the MODE button to access the PUMP SETUP MENU. The LED display will briefly show “SETUP”, and then enter the pump setup menu. Each setup parameter includes a TITLE screen followed by a VALUE screen. Within the pump setup menu, use the MODE button to cycle forward through the menu screens; use the PRIME button to cycle in reverse.

While a changeable value is displayed, use the UP and DOWN ARROW buttons to modify the value. Depending on the pump model, certain values may not be changeable.

To exit the pump setup menu and save all changes, press the RUN/STOP button. Note that changes will NOT be saved until the RUN/STOP button is pressed; exiting the pump setup menu by turning the instrument power off will discard all changes.

Firmware Identification:

The first setup parameter displayed is the instrument firmware identification, denoted by the title screen “F-Id”. Press the MODE button to advance the menu screen to display the firmware part number.

Firmware Version:

The next setup parameter displayed is the instrument firmware version, denoted by the title screen “Ver”. Press the MODE button to advance the menu screen to display the firmware version.

Flow Compensation:

The next setup parameter displayed is the flow rate compensation, denoted by the title screen “Cal”. Press the MODE button to advance the menu screen to display the flow rate compensation value, a number between 85.0 and 115.0

which represents the amount of compensation affecting the running speed of the pump, in percentage. The nominal value is 100.0, and indicates that the pump is running at 100.0% of the intended speed, meaning there is no secondary adjustment. A value of 98.7 means the pump is running 1.3% slower than nominal; a value of 106.4 means the pumps is running 6.4% faster than nominal.

Motor Stall Detector:

The next setup parameter displayed is the motor stall detector, denoted by the title screen “Stall”. Press the MODE button to advance the menu screen to display the motor stall detector state, either on (enabled) or off (disabled). While enabled, the motor stall detector creates a motor stall fault when the motor rotation is not properly detected.

Solvent Select:

The next setup parameter displayed is the Solvent Select feature, denoted by the title screen “S-Sel”. Press the MODE button to advance the menu screen to display the currently selected solvent, or OFF if this feature is disabled. Solvent Select allows the pump to produce accurate flow rates for various solvents.

PUMPED LIQUID	DISPLAY 2 ACRONYM	COMPRESSIBILITY (10 ⁻⁶ per bar)
Acetonitrile	ACn	115
Hexane	C6H14	167
Isopropanol	IPA	84
Methanol	CH3OH	121
Tetrahydrofuran (THF)	C4H8O	54
Water	H2O	46

Leak Detector:

The next setup parameter displayed is the leak detector, denoted by the title screen “Drip”. Press the MODE button to advance the menu screen to display the leak detector state, either on (enabled) or off (disabled). While enabled, the leak detector creates a leak warning (default) or leak fault (configurable with LM2 command) when a leak is detected.

Analog Input Mode:

The next setup parameter displayed is the analog input mode, denoted by the title screen “Input”. Press the MODE button to advance the menu screen to display the currently selected analog input mode, either voltage (0-10Vdc) or current (4-20mA). Refer to Appendix A for additional details.

Analog Input Enable/Override:

The next setup parameter displayed is the analog input enable/override, denoted by the title screen “An-En”. Press the MODE button to advance the menu screen to display the analog input enable/override state, either on (enabled) or off (disabled). While enabled, the analog input enable/override allows the analog input to be used without the need to wire the enable line on the external control connector. Refer to Appendix A for additional details.

Constant Pressure PID Setup:

The next 3 setup parameters displayed are the PID parameters used by Constant Pressure pumps, denoted by the title screens “PID-P”, “PID-I”, and “PID-D”. For Constant Flow pumps, the value screens will display off.

See: <https://www.teledynessi.com/manuals> for more information.

Serial Baud Rate:

The next setup parameter displayed is the serial baud rate, denoted by the title screen “Baud”. Press the MODE button to advance the menu screen to display the current baud rate, either 9600 or 19200. Note that the RUN/STOP button must be used to exit the pump setup menu and save all changes; changes made to the baud rate will then become effective on the next power cycle.

Pressure Smoothing Filter:

The next setup parameter displayed is the pressure smoothing filter, denoted by the title screen “P-AvG”. Press the MODE button to advance the menu screen to display the pressure smoothing filter value, a number between 0 and 16 which represents how much smoothing is applied to the pressure signal. Higher values denote increased smoothing.

Low Pressure Column Sensor:

Not available on the MX model pumps.

Non-volatile Memory Reset

On power-up, press and hold the UP ARROW button perform an instrument reset. The LED display will briefly show “reset”, and then enter the normal pump operating menu. A rest restores the instrument to its original factory settings. A reset automatically occurs when the firmware is updated.

Rear Panel Remote Input

RS-232C, Micro-USB and Ethernet ports are provided on the back panel (Figure 3). A computer with appropriate software can be used to control the pump operation remotely via these connections.

See Appendix A for details on connection and operation.

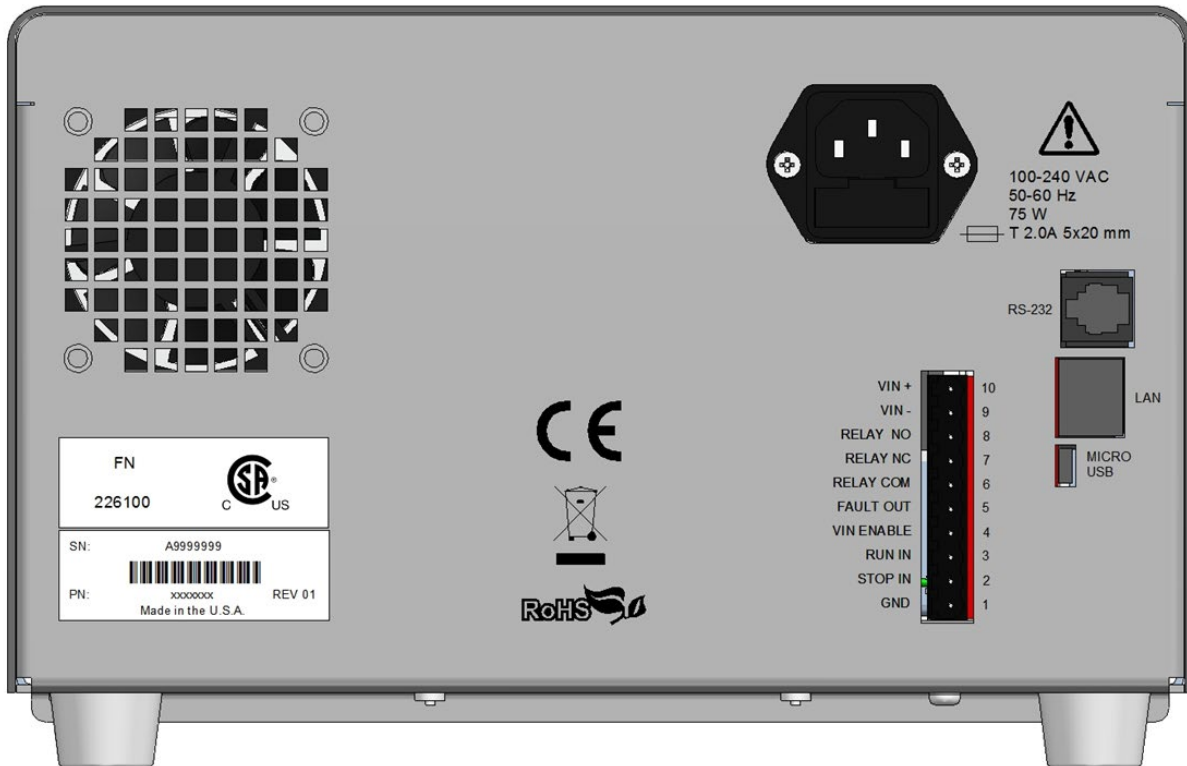

Figure 3. CP-Class Pump Rear Panel



WARNING: To avoid electric shock, do not remove the pump's protective cover. To avoid nonlethal electric shock when the pump is in operation, avoid touching the areas marked with the high voltage warning symbol. Remove the power cord and turn the pump off before touching these areas.

5. MAINTENANCE

Cleaning and minor repairs of the CP-Class Pump can be performed as outlined below.

Recommended Spare Parts Lists

Pump specific Recommended Spare Parts Lists are included with this pump in the box. The spare parts list can also be accessed through our website, by entering the pump's serial number at the following address:

<https://teledynessi.com/support/spare-parts-lookup>

The pump serial number is included on the front cover of the manual, and on the back of the pump.

Filter Replacement

Inlet Filters

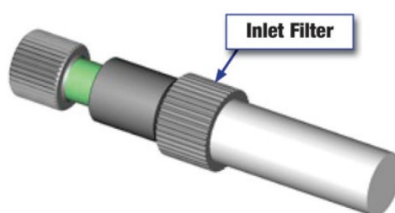

Figure 4, Inlet Filter

Inlet filters should be checked periodically to ensure that they are clean and not restricting flow. A restriction could cause cavitation and flow loss in the pump. Two problems that can plug an inlet filter are microbial growth and impure solvents. To prevent microbial growth, use at least 10-20% organic solvent in the mobile phase or add a growth-inhibiting compound. If 100% water or an aqueous solution is pumped without any inhibitors, microbes will grow in the inlet filter over time, even if fresh solution is made every day. Always use well filtered, HPLC grade solvents for the mobile phase.

Outlet Filter

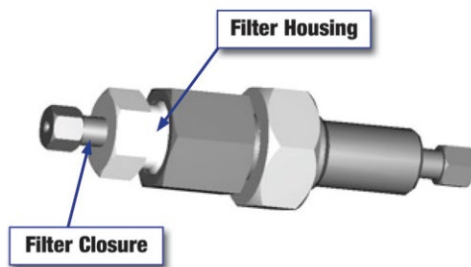

Figure 5, Outlet Filter

To service the outlet filter on stainless steel pumps:

1. Using a 5/8" wrench to hold the filter housing at the pump, and a 1/2" wrench to remove the filter closure, remove the filter closure assembly.
2. Use a seal insertion/removal tool or a non-metallic object (such as a wooden toothpick) to remove the large seal that remains in the housing.



CAUTION: Do not use a metal object such as a screwdriver or paperclip to remove the seal. Doing so can scratch the precision surface of the seat and may cause the filter to leak.

3. Unscrew the old filter and remove the small seal from the filter closure.
4. Place one of the small seals included in the replacement element kit over one of the new filters from the kit. Screw the new filter into the filter closure (finger tight).
5. Place one of the large seals from the replacement kit on the filter closure. Insert the filter closure into the housing and tighten $\frac{1}{4}$ turn after seating.

To service the outlet filter on Hastelloy pumps:

1. Using a $\frac{5}{8}$ " wrench to hold the filter housing at the pump, and a $\frac{1}{2}$ " wrench to remove the filter closure, remove the filter closure assembly.
2. Use a seal insertion/removal tool or a non-metallic object (such as a wooden toothpick) to remove the large seal that remains in the housing.
3. Remove the filter frit from the filter closure with a small flat blade screwdriver inserted into the closure slot.
4. Insert the new filter frit into the filter closure on a clean flat surface until seated completely into the closure.
5. Install the Teflon housing gasket onto the shoulder of the filter closure. Insert the filter closure into the filter housing and tighten $\frac{1}{4}$ turn after seating.

Pump Head Assemblies



CAUTION: When working with aggressive or toxic solvents, residual amounts of these chemicals could be present in the system.

Removing the Pump Head Assembly

The two figures below show the various fluid path material options for the pump head assemblies.

To remove the pump head:

1. Turn OFF the pump power.
2. Unplug the power cord.
3. Remove the inlet line and filter from the mobile phase reservoir. Be careful not to damage the inlet filter or crimp the PTFE tubing.
4. Remove the inlet line from the inlet check valve.
5. Remove the outlet line from the outlet check valve.
6. Remove the inlet and outlet self-flush lines.
7. Carefully remove the two Allen nuts at the front of the pump head with a $\frac{3}{16}$ " Allen wrench. For the Jacketed Hastelloy pump head, the cap must be removed to access the Allen nuts.



CAUTION: Be careful not to break the piston when removing the pump head. Twisting the pump head can cause the piston to break.

8. Carefully separate the pump head from the pump.
 - a. Move the pump head straight out from the pump and remove it from the piston. **Be careful not to break or damage the piston.**
 - b. Remove the seal and seal backup washer from the piston if they did not stay in the pump head.
 - c. Remove the O-ring.
9. Carefully separate the self-flush housing from the pump. Move the flush housing straight out from the pump and remove it from the piston. Also remove the self-flush seal or guide bushing from the piston if it did not stay in the flush housing.

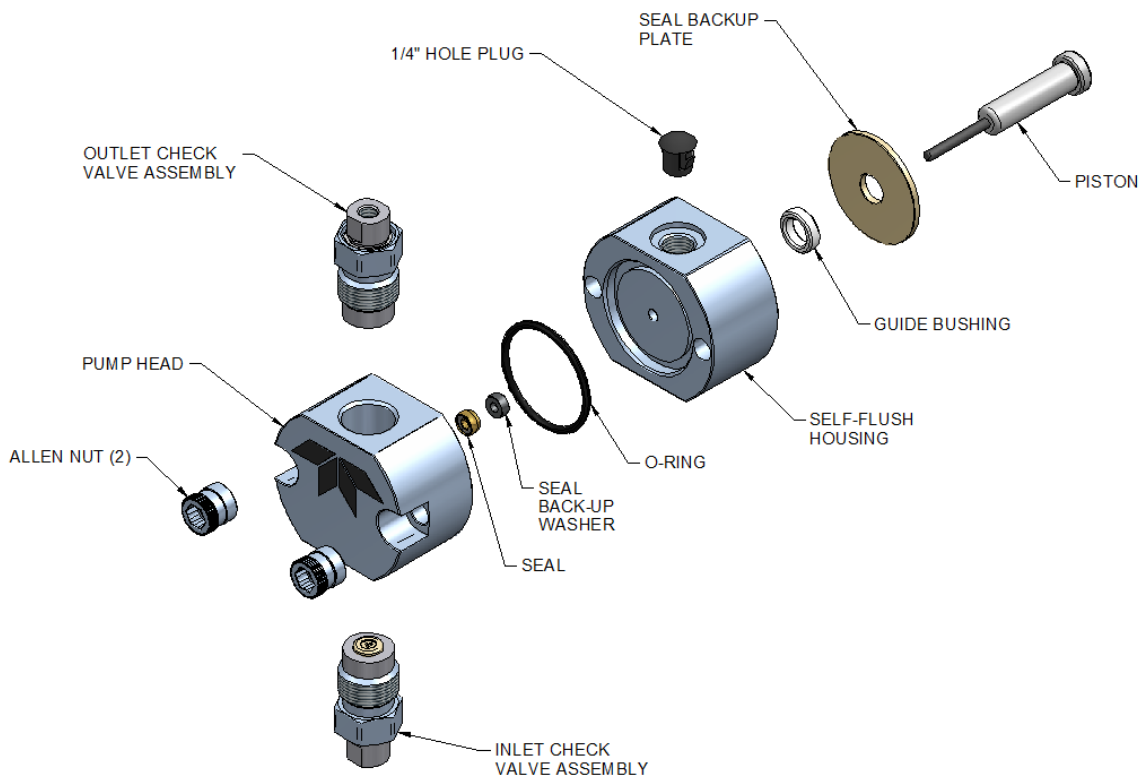

Figure 6. *Stainless Steel Non-Flushing Pump Head Assembly*

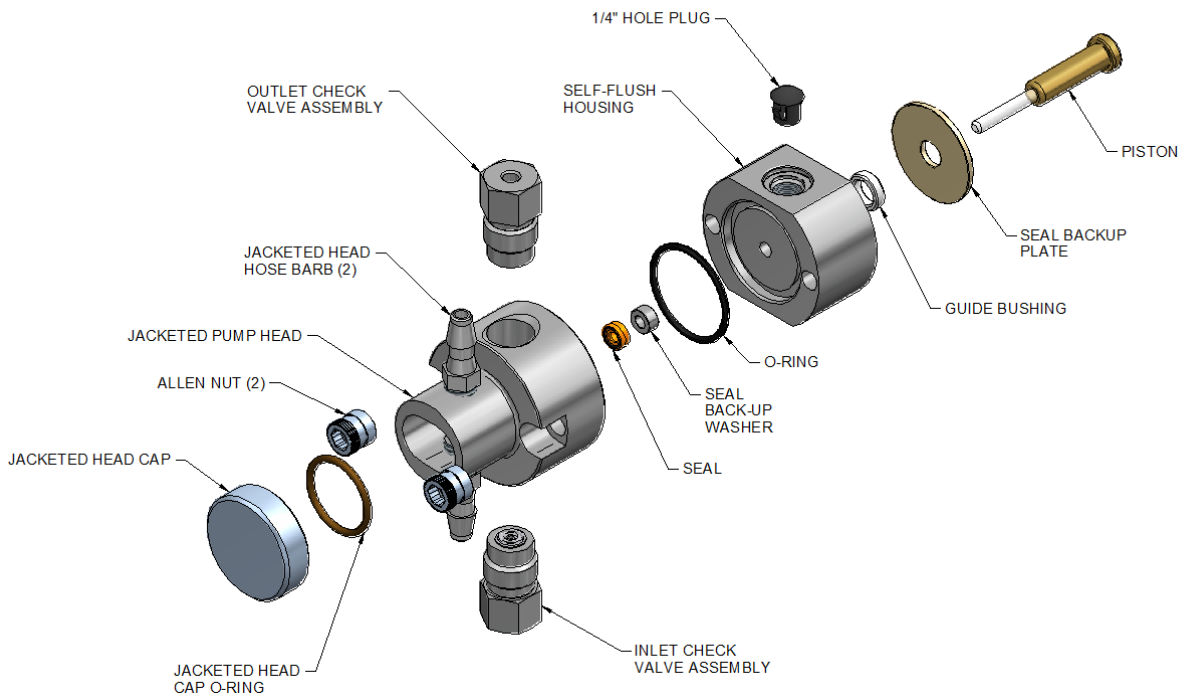

Figure 7. *Jacketed Hastelloy Non-Flushing Pump Head Assembly*

Cleaning the Pump Head Assembly

Note: If the piston seal or self-flush seal are going to be removed, it is recommended to have a new set on hand to install after cleaning. It is not recommended to reinstall the used piston seal or self-flush seal since they are likely to be scratched and damaged during removal and would not provide a reliable seal if reused. If the seals are removed, use only the flanged end of the plastic seal removal tool supplied with the seal replacement kit, and avoid scratching the sealing surface in the pump head.

Inspect the piston seal cavity in the pump head. Remove any foreign material using a cotton swab or equivalent, and avoid scratching the sealing surfaces. Be sure no fibers from the cleaning swab remain in the components.

The pump head, check valves, and flushing housing may be further cleaned using a laboratory grade detergent solution in an ultrasonic bath for at least 30 minutes, followed by rinsing for at least 10 minutes in distilled water. Be sure that all particles loosened by the above procedures have been removed from the components before reassembly.

Replacing the Pump Head

1. Carefully align the flush housing and gently slide it into place on the pump. Make sure that the Inlet self-flush check valve is on the bottom and the Outlet self-flush check valve is on the top. If misalignment with the piston occurs, gently realign the piston holder.
2. Install the O-ring in its groove.
3. Line up the pump head and carefully slide it into place. Be sure that the Inlet valve is on the bottom and the Outlet valve is on the top. Do not force the pump head into place.
4. Finger tighten the allen nuts into place. To tighten firmly, alternately turn nuts 1/4 turn with a suitable tool (alternating side-to-side) while gently rotating the pump head to center it.
5. Torque the Allen nuts to 30 in-lbs using a suitable torque wrench and 3/16" hex adaptor.
6. Reattach the inlet and outlet lines. If the Self-Flush feature is used, reattach the self-flush lines and change the flushing solution.

Piston Seals

Lower than normal pressure, pressure variations, and leaks in the pumping system can all indicate possible problems with the piston seal. Depending on the fluid or mobile phase used, piston seal replacement is often necessary after 1000 hours of running time.

Removing the Seals

1. Remove the pump head and self-flush assemblies as described above.
2. Remove the backup washer if it is present in the pump head.
3. Insert the flanged end of the seal insertion/removal tool into the seal cavity on the pump head. Tilt it slightly so that flange is under the seal and pull out the seal.



CAUTION: Using any other “tool” will scratch the finish of the sealing surface and create a leak.

4. Repeat the procedure for the low-pressure seal in the flush housing.
5. Inspect, and if necessary, clean the pump head as described above.

Replacing the Seals

1. Place a **high pressure replacement seal** (*Figure 8*) on the rod-shaped end of the seal insertion/removal tool so that the energizer is visible when the seal is fully seated on the tool. Insert the seal into the pump head. Be careful to line up the seal with the cavity while inserting. Then, withdraw the tool, leaving the seal in the pump head. When looking into the pump head cavity, only the polymer side of the seal should be visible.
2. Place a **self-flush replacement seal** on the seal insertion/removal tool so that the energizer in the seal is visible when the seal is on the tool. As in the previous step, insert the tool and seal into the seal cavity on the flushing housing, taking care to line up the seal with the cavity, and then withdraw the tool. When the seal is fully inserted, only the polymer side of the seal will be visible in the seal cavity.

NOTE: If the self-flush feature is not being used, install the provided guide bushing in the place of the self-flush seal.

3. Place the seal back-up washer over the high-pressure seal in the pump head.
4. Replace the self-flush and pump head assemblies.

NOTE: for 5 and 12 mL pumps, take care to install the back-up washer in the proper orientation, as shown in Figure 8 above.

5. Condition the new seals as described below.

Conditioning New Seals

New seals should be conditioned prior to use. Conditioning is the process of running the seals wet under controlled conditions to allow surfaces to seat and to prepare the seal for operation.

Note: Use only organic solvents to condition new seals. Buffer solutions and salt solutions should never be used to condition new seals. Recommended solvents are HPLC-grade methanol and isopropanol, and water mixtures of either.

Suggested Conditioning Parameters: Using a restrictor coil or a suitable column, run the pump with a 50:50 solution of isopropanol (or methanol) and water for 30 minutes at the back pressure and flow rate listed under PHASE 1 in the following chart and according to the pump head type. Then run the pump for another 15 minutes under conditions for PHASE 2 in the following chart, according to pump flow and pressure capabilities.

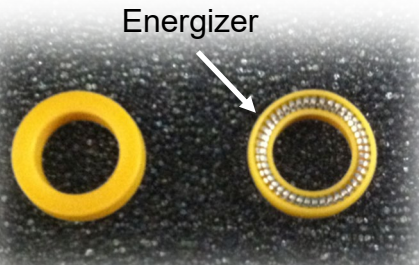

*Figure 8,
Example of polymer side
vs. energizer side of seal.
(Note, stainless steel
energizer shown. Seal
could have fluoropolymer
o-ring energizer instead
(black o-ring).*

Seal Conditioning Parameters		
Flow Rate Setting	Pressure (psi) Phase 1	Pressure (psi) Phase 2
20-30% of Maximum Pump Flow	*1,000	*1,500
* - or 95% of Maximum pump capability		

Pistons

Cleaning the Piston

1. After the pump head and self-flush housing are removed, gently remove the backup seal plate from the pump housing, using either a small screwdriver or toothpick in the slot on top of the pump housing.
2. Grasp the metal base of the piston assembly to avoid exerting any side load on the sapphire rod and remove the piston from the slot in the carrier by sliding it up.
3. Use the scouring pad included in the seal replacement kit to clean the piston. Gently squeeze the piston within a folded section of the pad and rub the pad along the length of the piston. Rotate the pad frequently to assure the entire surface is scrubbed. Do not exert pressure perpendicular to the length of the piston, as this may cause the piston to break. After scouring, use a lint-free cloth, dampened with alcohol, to wipe the piston clean.
4. To reinstall the piston, grasp the metal base of the piston assembly and insert it into the slot in the piston carrier until it bottoms in the slot.

Replacing the Piston

Remove the pump head and self-flush assemblies.

1. Grasp the metal base of the piston assembly to avoid exerting any side load on the sapphire rod and remove the piston from the slot in the carrier by sliding it up.
2. Grasp the metal base of the replacement piston assembly, and insert it into the slot in the piston carrier until it bottoms in the slot.
3. Replace the pump head as described above.

Check Valve Cleaning and Replacement

Many check valve problems are the result of small particles interfering with the operation of the check valve. As a result, simply cleaning the pump head with the appropriate laboratory apparatus may resolve any issues.

Check Valve Cleaning

1. To clean pump check valves, remove the pump head and immerse the entire head into a laboratory ultrasonic cleaner.
2. Sonicate for about 30 minutes using a standard cleaning solution. Rinse the pump head thoroughly with distilled water.
3. Replace the pump head assembly.
4. Run the pump at 1 mL/min (3 mL/min for a 100 mL pump head) with distilled water for fifteen minutes. Always direct the output directly to a waste beaker during cleaning (do not recycle).

If this procedure does not return the pump to proper performance, the check valves should be replaced. An example of new check valves from their package can be seen in *Figure 9* below.

Check Valve Replacement

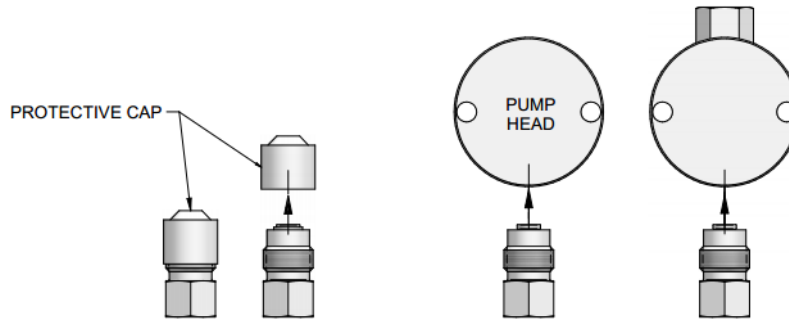

Figure 9, New Check Valves from package and proper orientation.

5. Remove the pump head assembly.
6. Remove the check valve housings, capsules and seals from the pump head, being careful not to scratch the sealing surfaces in the pump head. If necessary, use a seal removal tool to remove the capsules and/or capsule seals from the pump head.



CAUTION: Be careful not to break the piston when removing the pump head. Twisting the pump head can cause the piston to break.



CAUTION: Make sure check valve is kept in the above position to avoid losing parts

Note: The size of the through-holes in the pump head. If one is larger, then this side attaches to the Inlet check valve assembly. If the through-holes are the same size, then the orientation does not matter.

7. Hold one new check valve assembly as shown in *Figure 9* and unscrew the protective cap. With the check valve assembly maintained in the above position, thread it into the proper pump head port until it is snug. Install the other check valve assembly similarly.

NOTE: It may be easier to install the Outlet check valve first (if the hole sizes are different), from below; then turn the pump head upside down and install the Inlet check valve.

8. Reinstall the pump head assembly
9. Tighten the check valve housings to 75 in-lbs (120 in-lbs on 5 mL and 12 mL pumps), or enough to seal at maximum pressure.
10. Reattach the solvent inlet and outlet lines.
11. If the Self-Flush feature is being used, the self-flush lines to the self-flush check valves.

Self-Flush Check Valves

Self-flush check valves can be replaced without removing the pump head of self-flush assembly, and do not require any tools for Stainless Steel pumps. Hastelloy Self-Flush check valves should be torqued to 15 inch-lbs. When installing new check valves, notice the outlet has a transparent washer, and the Inlet has a cross ball retainer. Also, the words INLET and OUTLET should be visible on the top of the self-flush check valves.

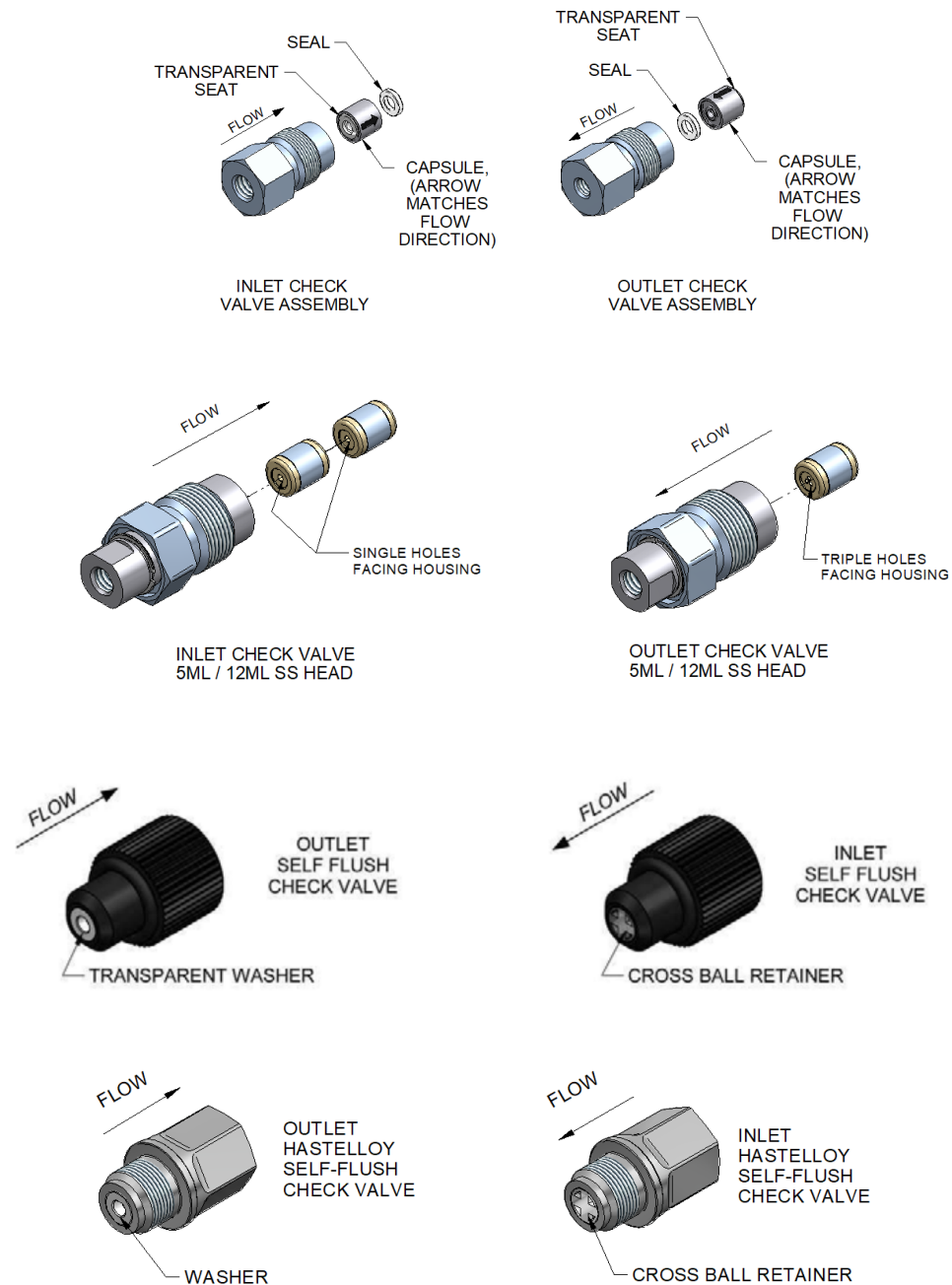

Figure 10, Check Valve Assemblies for Stainless Steel (SS) and Hastelloy, and also for the Self-Flush Housing

Note: The Sapphire Seat is an opaque white ring. The red ruby ball can be seen through the ring. Flow is always away from the sapphire seat, as shown by the directional arrows etched on the capsules.

The capsules for 24 mL and 100 mL pumps also include one removable ETFE seal (as shown in *Figure 10* above). The seal may stick inside housing or pump head.

Note: (Does not apply to 5mL pumps): The **INLET** check valve has a **LARGER** opening (1/4"-28, flat bottom seat) for the 1/8" inlet tubing;

The **OUTLET** check valve has a **SMALLER** opening (#10-32, cone seat) for the 1/16" outlet tubing.

NOTE: (5mL pumps only): The **INLET** check valve has a **DEEPER** chamber to fit two check valve capsules; the **OUTLET** check valve has a **SHALLOWER** chamber to fit one check valve capsule.

Cleaning the Pump

1. Prepare the following solvents, utilizing the solvent preparation methods detailed in the above section:
 - a. 100% isopropanol
 - b. 100% filtered, distilled water
 - c. 20% nitric acid/water solution (only prepare if the flow path is stainless steel)
2. Direct the pump outlet line to a waste beaker.
3. Press the PRIME (P) button to set the pump flow rate to maximum.
4. Pump 100% isopropanol through the pump for 3 minutes.
5. Pump 100% filtered, distilled water through the pump for 3 minutes.



WARNING: Use standard laboratory procedures and extreme care when handling strong acids and bases.

6. Pump a 20% nitric acid/water solution through the pump for 3 minutes.
7. Flush the pump with 100% filtered, distilled water for at least 3 minutes.
8. Pump 100% isopropanol through the pump for 3 minutes.

The pump is now prepared for any mobile phase or short- or long-term shutdown.

Lubrication

The CP-Class pump has modest lubrication requirements. The bearings in the pump housing and piston carrier are permanently lubricated and require no maintenance. A small dab of a light grease such as Lubriplate 630-AA on the cam is the only recommended lubrication. Be sure not to get lubricant on the body of the piston carrier, as this can retard its movement and interfere with proper pumping. Keeping the interior of the pump free of dirt and dust will extend the pump's useful life.

Fuse Replacement

Two fuses are located in the power entry module at the rear of the cabinet.

Troubleshooting the fuses is straightforward. If the power cord is plugged in and the on/off power switch is on and the fan does not run, check the two fuses in the power entry module. To gain access to these fuses, gently pry off the cover plate with a small flat-bladed screwdriver (*Figure 11*).

Replace with 2 amp fuses, 5x20mm, Slo-Blo (time-lag), 250V

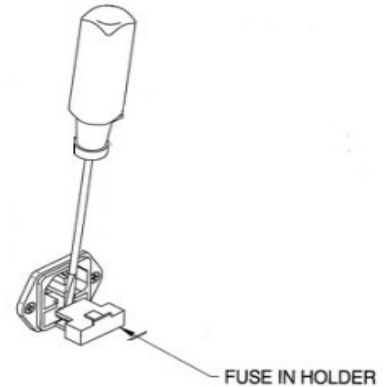

Figure 11, Fuse replacement

Fitting Adapter Kits

For Stainless Steel Fluid Path Models

The fitting adapter kit included with this pump is intended for conversion of the inlet connection to 1/8" O.D. rigid tubing, and/or the outlet connection to 1/8" O.D. rigid tubing.

To convert the inlet connection:

1. Using a 1/2" wrench, remove the inlet check valve housing, making sure to retain the check valve capsule and washer.

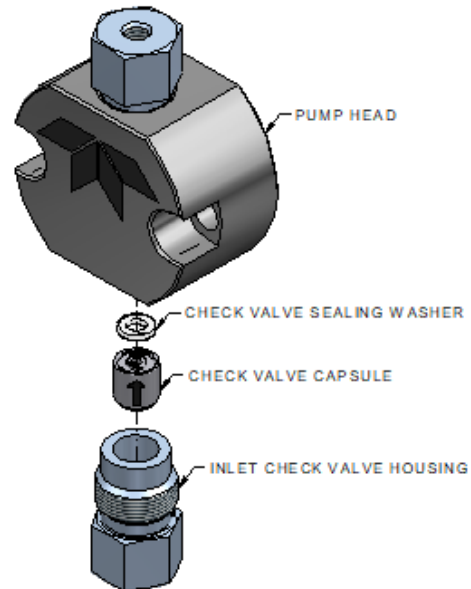

2. Install the check valve capsule into the new 1/8" OD tubing inlet housing as shown.

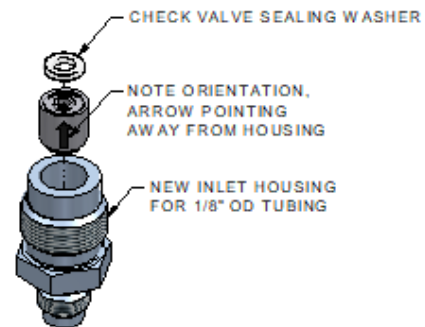

3. Install new check valve assembly into the inlet of the pump head. Torque the check valve housing to 75 in-lbs.

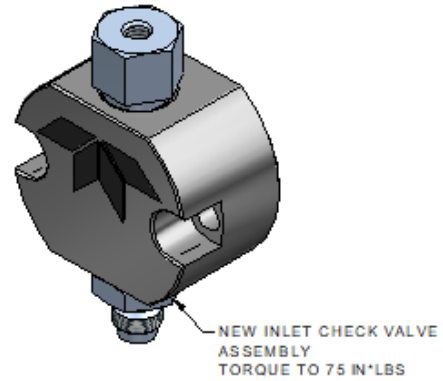

4. Customer supplied 1/8"OD tubing can now be connected to the inlet of the pump. *Note – minimum tubing ID for inlet of pump should not be less than 0.085", or cavitation may occur.

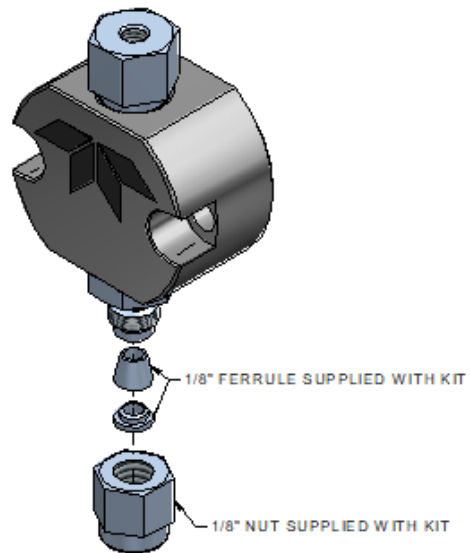

To convert the outlet connection:

1. Use a 5/8" wrench to hold the filter housing at the pump, and a 1/2" wrench to remove the filter closure assembly, loosen closure and pull the filter closure assembly out of the filter housing, making sure to remove the PEEK filter housing gasket with the closure assembly.

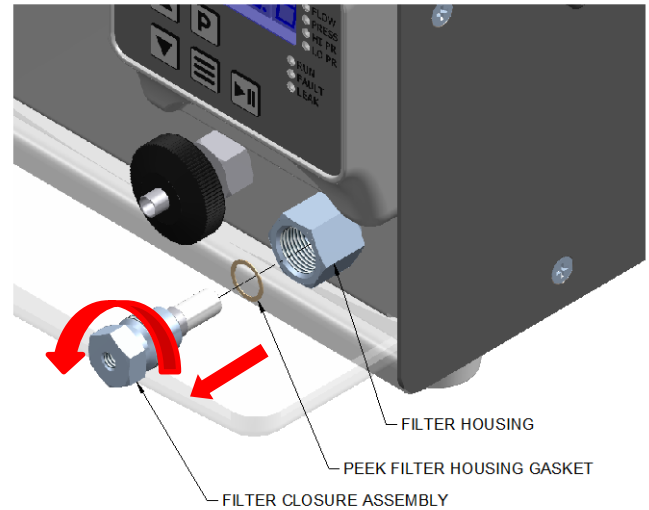

2. Install the new filter housing gasket onto the closure assembly and install into the filter housing making sure the gasket remains on the shoulder of the closure when installing into the filter housing, tightening by hand. Use a 5/8" wrench to hold the filter housing and torque the new filter closure assembly into the filter housing to 180 in*lbs, or 1/4 turn past hand tight.

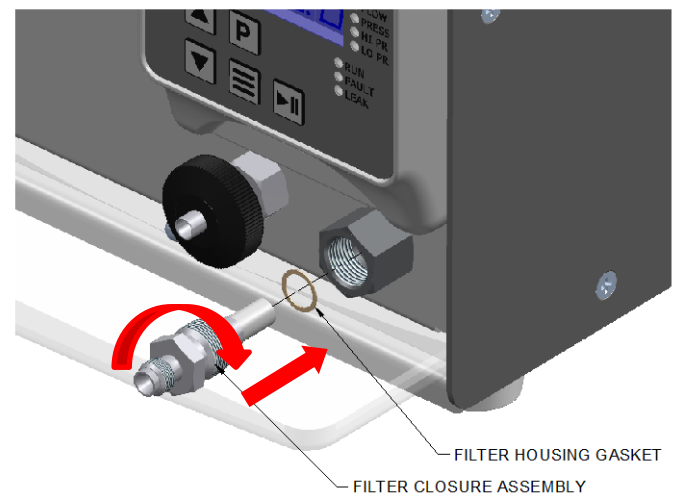

3. Customer supplied 1/8"OD tubing can now be connected to the outlet of the pump using the nut and ferrules supplied with the adapter kit.

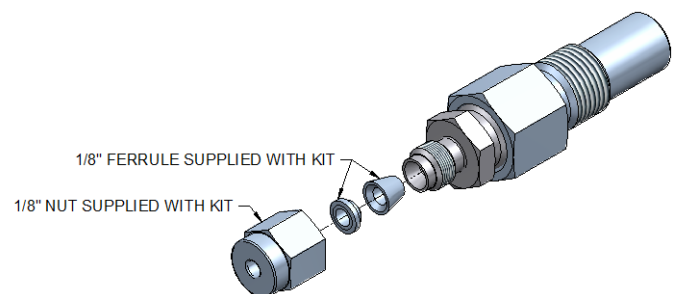

For Hastelloy Fluid Path Models:

To convert the outlet connection:

1. Use a 5/8" wrench to hold the filter housing at the pump, and a 1/2" wrench to remove the filter closure assembly, loosen closure and pull the filter closure assembly out of the filter housing, making sure to remove the PTFE filter housing gasket with the closure assembly.

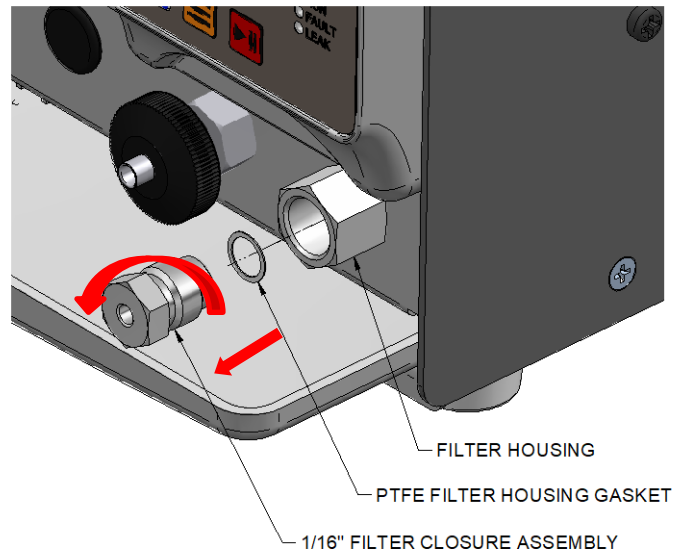

2. Install the new filter housing gasket onto the closure assembly and install into the filter housing making sure the gasket remains on the shoulder of the closure when installing into the filter housing, tightening by hand. Use a 5/8" wrench to hold the filter housing and torque the new filter closure assembly into the filter housing to 180 in*lbs, or 1/4 turn past hand tight.

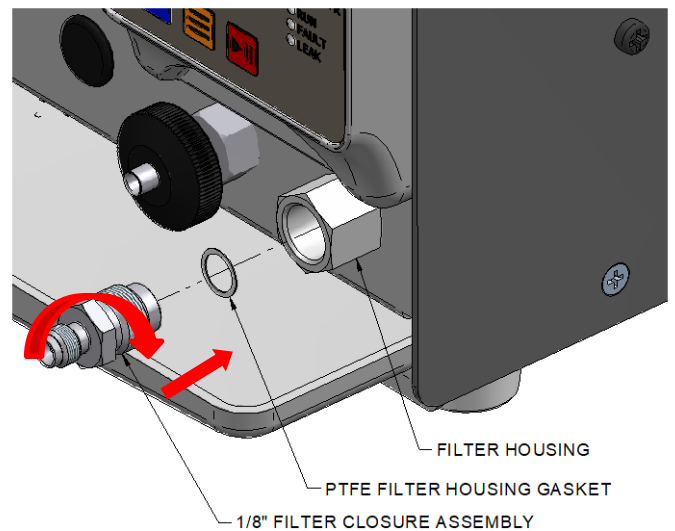

3. Customer supplied 1/8"OD tubing can now be connected to the outlet of the pump using the nut and ferrules supplied with the adapter kit.

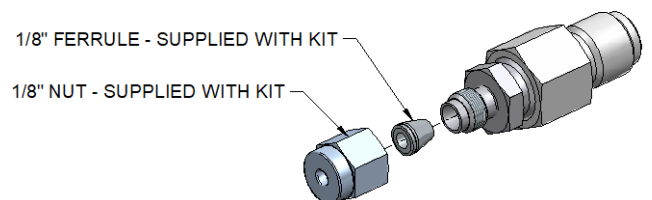

6. QUICK GUIDE TO PROBLEM SOLVING

Noticed Issue	This May Mean	Possible Cause	Possible Solution
<ol style="list-style-type: none"> 1. Uneven pressure trace. 2. Pressure drops. 3. No flow out the outlet check valve. 	<ol style="list-style-type: none"> 1. Bubble in check valve. 2. Leaks in system. 3. Dirty check valve. 4. Bad check valve. 	<ol style="list-style-type: none"> 1. Solvent not properly degassed. 2. Fittings are not tight. 3. Mobile phase not properly filtered. 4. Particles from worn piston seal caught in check valve. 5. Plugged inlet filter. 	<ol style="list-style-type: none"> 1. Check to be certain that mobile phase is properly degassed. 2. Check connections for leaks by tightening fittings. 3. Prime the system directly from the outlet check valve. 4. Clean or replace the check valves. 5. Clean or replace inlet filter.
<ol style="list-style-type: none"> 1. Uneven pressure trace. 2. Pressure drops. 3. Fluid between the pump head and the retainer. 	<ol style="list-style-type: none"> 1. Leaks in system. 2. The piston seal or self-flush seal is worn. 	<ol style="list-style-type: none"> 1. Fittings not tight. 2. Long usage time since last piston seal / self-flush seal change. 3. Salt deposits on seal or self-flush seal (especially if buffered aqueous mobile phases are used). 	<ol style="list-style-type: none"> 1. Check all connections for leaks. 2. Replace piston seal & self-flush seal. 3. Check the piston for salt deposits. Clean as necessary.
Pump makes a loud clanging or slapping noise (intermittent contact with cam).	Piston carrier is catching in piston guide.	<ol style="list-style-type: none"> 1. Cap nut screws on the pump head are loose. 2. Seal(s) are worn. 3. Piston guide is worn 	<ol style="list-style-type: none"> 1. Check cap nut screws on pump head. Tighten if necessary. 2. Replace seals. 3. Replace piston guide and seals.
No power when pump turned ON.	Blown fuses in the power entry module.	<ol style="list-style-type: none"> 1. Power surge. 2. Internal short. 	<ol style="list-style-type: none"> 1. Replace only with the appropriate fuses. 2. Contact service technician if problem persists.
Pump runs for 50 pump strokes, then shuts down.	Lower pressure limit is activating.	<ol style="list-style-type: none"> 1. Mobile phase is not properly filtered. 2. Particles from worn seal trapped in the system (e.g., tubing, filters, injection valve, or column inlet). 	<ol style="list-style-type: none"> 1. Check to be certain the low pressure limit is set to 0 psi. 2. Only increase the low pressure limit after the pump attains operating pressure. 3. Contact service technician.
<ol style="list-style-type: none"> 1. Pump shuts down after run is called even with no column connected. 2. Pump runs to maximum pressure and shuts down. 	Clog in fluid system.	<ol style="list-style-type: none"> 1. Particulate matter clogging inlet system or head of column. 2. Plugged detector line. 3. Injection valve improperly positioned. <p>Column inlet clogged with dirt accumulation.</p>	<ol style="list-style-type: none"> 1. Filter mobile phase and sample. 2. Check syringe for a barb(s) breaking septa pieces off into the system. 3. Turn pump off immediately and carefully clean lines and cell. 4. Check injection valve for proper rotation. Clean inlet and/or replace column.
No power when pump turned ON. Fan does not run.	Blown fuses in the power entry module.	<ol style="list-style-type: none"> 1. Power surge. 2. Internal short. 	<ol style="list-style-type: none"> 1. Replace only with the appropriate fuses. 2. Contact service technician if problem persists.

7. APPENDIX A

Rear Panel Serial Communications Port

A USB 2.0 Micro-B, RJ12 6P6C RS-232C, and RJ45 Ethernet (LAN) ports are provided on the back panel. The SSI Pump Communication Guide may be downloaded from the Teledyne SSI website at the following address:

<https://www.teledynessi.com/Manuals%20%20Guides/Product%20Guides%20and%20Resources/Serial%20Pump%20Control%20for%20Next%20Generation%20SSI%20Pumps.pdf>

A computer with appropriate software can be used to control the pump operation remotely via these connections. Additional drivers may be required for utilization of the USB port. The proper driver may be downloaded from the Teledyne SSI website at the following address: <https://www.teledynessi.com/driver-downloads>

Hardware Implementation

The RS-232 REMOTE INPUT serial communications port is configured by default for 9600 baud, 8 data bits, 1 stop bit, and no parity. The connector is a standard RJ12 modular telephone type jack. When looking at the connector on the rear panel of the pump, pin 1 is at the top and pin 6 is at the bottom. The pin-out is:

Pin.....	Function
1, 6	Ground
2	DSR (Handshaking input to pump)
3	RXD (Serial data input to pump)
4	TXD (Serial data output from pump)
5	DTR (Handshaking output from pump)

Special wiring considerations: Use the following chart for interfacing the pump's serial communications port to either a 25-pin or a 9-pin COM port on a PC.

Pump (RJ12).....	Signal	IBM (DB25) ^a	IBM (DE9) ^b
1, 6	Ground	7	5
2	DSR	20	4
3	RXD	2	3
4	TXD	3	2
5	DTR	6	6

^a Jumper pins 4, 5, and 8 on DB25.
^b Jumper pins 1, 7, and 8 on DE9.

Command Interpreter

The pump's high-level command interpreter receives and responds to command packets. The pump will not send a message except when prompted, and it will send a response to every valid command as described below. The response to an invalid command is "Er".

Each command is characterized by a unique two-letter command code. Commands are not case sensitive; that is, the command codes "PR" "Pr" "pR" and "pr" are all equivalent. Response strings sent by the pump are terminated by the "/" character.

If the pump's response is "Er/", sending a "#" to clear any characters remaining in the command buffer may be beneficial. The pump will automatically clear all characters in the command buffer after one second elapses from the time at which the last character of an incomplete command was received.

Optionally, a carriage return may be used to indicate the end of a transmitted string. A received carriage return will cause the pump to immediately respond to the received command, and may help speed communications.

Pump Command List

GENERAL COMMANDS			
<u>Command</u>	<u>Response</u>	<u>Description</u>	<u>Example</u>
CC	OK,<pressure>,<flow>/	Current Conditions: returns the following values: <pressure>: current operating pressure <flow>: current flow rate in ml/min	OK,0522,12.00/
CF	OK/	Clear Faults: clears any active faults.	OK/
CS	OK,<flow>,<UPL>,<LPL>,<p_units>,<R/S>,0/	Current Status: returns the following values: <flow>: current flow rate* in ml/min <UPL>: Upper Pressure Limit <LPL>: Lower Pressure Limit <p_units>: pressure units <R/S>: Run/Stop state, where 0 = stop, 1 = run *CP pumps return flow rate set point	OK,12.00,10000,0000,psi,0,0,0/
FIxxxxx	OK,FI:<flow>/	Flow Input: sets the flow rate using up to 5 digits. If the entered value exceeds the maximum allowable flow rate of the pump, the flow rate will be automatically set to the maximum allowable flow rate.	OK,FI:01200/
GS	OK,GS:<seal>/	Get Seal: returns the seal-life stroke counter value.	OK,GS:7/
ID	OK, <ID> Version <ver>/	ID: returns the firmware version and part number. <ID>: firmware part number <ver>: firmware revision	OK, 196000 Version 1.0.0/
KD	OK/	Keypad Disable: disables front panel buttons.	OK/
KE	OK/	Keypad Enable: enables front panel buttons.	OK/

GENERAL COMMANDS (continued)

<u>Command</u>	<u>Response</u>	<u>Description</u>	<u>Example</u>
MF	OK,MF:<max_flow>/	Maximum Flow: returns the maximum allowable flow rate for the pump, in ml/min.	OK,MF:12.00/
PI	OK,<flow>,<R/S>,<p_comp>,<head>,0,1,0,0,<UPF>,<LPF>,<prime>,<keypad>,0,0,0,0,<stall>/	<p>Pump Information: returns the current pump information.</p> <p><flow>: current flow rate* in ml/min <R/S>: run/stop state, where 0 = stop, 1 = run <p_comp>: manual pressure compensation value <head>: head identification <UPF>: upper pressure fault status <LPF>: lower pressure fault status <prime>: 0 = not in prime, 1 = in prime <keypad>: 0 = keypad buttons enabled, 1 = disabled <stall>: 0 = no motor stall fault, 1 = faulted</p> <p>*CP pumps return flow rate set point</p>	OK,12.00,0,0,S10D,0,1,0,0,0,0,0,0,0,0,0/
RE	OK/	Reset: reset all user adjustable values to factory defaults. This includes the flow rate, upper pressure limit, lower pressure limit, selected solvent, flow rate compensation, and CP values.	OK/
RF	OK,<stall>,<UPF>,<LPF>/	<p>Read Faults: returns status of all fault indicators, where 0 = no fault, 1 = fault.</p> <p><stall>: motor stall fault <UPF>: upper pressure fault status <LPF>: lower pressure fault status</p>	OK,0,0,0/
RU	OK/	Run: run the pump.	OK/
ST	OK/	Stop: stop the pump.	OK/

GENERAL COMMANDS (continued)

<u>Command</u>	<u>Response</u>	<u>Description</u>	<u>Example</u>
UC	OK,UC:<user_comp>/	User Compensation: returns the user flow rate compensation, where xxx.x = xxx.x % e.g. UC:102.5/ = 102.5% compensation (+2.5%)	OK,UC:100.0/
UCxxxx	OK,UC:<user_comp>/	User Compensation: stores the user flow rate compensation, where xxx.x = xxx.x % e.g. UC102.5 = 102.5% compensation (+2.5%) input range: 0850 to 1150 (i.e. ± 15.0%)	OK,UC:100.0/
ZS	ZS:OK/	Zero Seal: reset the seal-life stroke counter to zero.	ZS:OK/
#	(no response)	Clears all characters from the command buffer.	

LEAK SENSOR COMMANDS

**The following commands are active ONLY for instruments with a LEAK SENSOR.
All other instruments will respond with error message Er/.**

<u>Command</u>	<u>Response</u>	<u>Description</u>	<u>Example</u>
LS	OK,LS:<leak>/	Leak Status: returns the leak sensor status. 0 = no leak detected 1 = leak detected	OK,LS:0/
LMx	OK,LM:<mode>/	Leak Mode: sets the leak sensor mode. 0 = leak sensor disabled 1 = detected leak does not cause fault 2 = detected leak does cause fault	OK,LM:0/

PRESSURE COMMANDS

**The following commands are active ONLY for instruments with a PRESSURE SENSOR.
All other instruments will respond with error message Er/.**

<u>Command</u>	<u>Response</u>	<u>Description</u>	<u>Example</u>
PR	OK,<pressure>/	Pressure: returns the current operating pressure.	OK,0897/
MP	OK,MP:<max_pressure>/	Maximum Pressure: returns the maximum allowable pressure for the pump.	OK,MP:10000/
LP	OK,LP:<LPL>/	Lower Pressure: returns the lower pressure limit.	OK,LP:0000/
UP	OK,UP:<UPL>/	Upper Pressure: returns the upper pressure limit.	OK,UP:10000/
LPxxxxx	OK/	Lower Pressure: stores the lower pressure limit. psi input format: LP200 = 200 psi bar input format: LP200 = 20.0 bar MPa input format: LP200 = 2.00 MPa	OK/
UPxxxxx	OK/	Upper Pressure: stores the upper pressure limit. psi input format: LP200 = 200 psi bar input format: LP200 = 20.0 bar MPa input format: LP200 = 2.00 MPa	OK/
PU	OK,<p_units>/	Pressure Units: returns the pressure units.	OK,psi/

SOLVENT SELECT COMMANDS

**The following commands are active ONLY for instruments featuring Solvent Select.
All other instruments will respond with error message Er/.**

<u>Command</u>	<u>Response</u>	<u>Description</u>	<u>Example</u>
RS	OK,<solvent>/	Read Solvent: returns the compressibility value (10^{-6} per bar.)	OK,121/
SSxxx	OK/	Set Solvent: stores the compressibility value (10^{-6} per bar.)	OK/

ANALOG INPUT COMMANDS

The following commands are used to configure the analog input located on the rear panel terminal connector.

<u>Command</u>	<u>Response</u>	<u>Description</u>	<u>Example</u>
AM	OK,AM:<mode>/	<p>Analog Mode: returns the input mode. 0 = voltage input (0 – 10 Vdc) 1 = current input (4 – 20 mA)</p>	OK,AM:0/
AMx	OK,AM:<mode>/	<p>Analog Mode: sets the input mode. 0 = voltage input (0 – 10 Vdc) 1 = current input (4 – 20 mA)</p>	OK,AM:0/
AE	OK,AE:<mode>/	<p>Analog Enable: returns the analog input enable (override), which activates analog flow control regardless of the physical enable line state. 0 = override disabled: must connect enable line on external control board to activate analog input. 1 = override enabled: activates analog input regardless of external enable line state.</p>	OK,AE:0/
AE_x	OK,AE:<mode>/	<p>Analog Enable: sets the analog input enable (override), which activates analog flow control regardless of the physical enable line state. 0 = override disabled: must connect enable line on external control board to activate analog input. 1 = override enabled: activates analog input regardless of external enable line state.</p>	OK,AE:0/

4-20mA CURRENT INPUT CALIBRATION COMMANDS

The following commands are active **ONLY** when **4-20mA CURRENT INPUT MODE** is selected.
When **0-10V VOLTAGE INPUT** is selected, instruments will respond with error message Er/.

<u>Command</u>	<u>Response</u>	<u>Description</u>	<u>Example</u>
IO	OK,IO:<i_offset>/	Current Offset: returns offset value used in 4-20mA calibration, in A/D counts.	OK,IO:184/
IOxxxx	OK,IO:<i_offset>/	Current Offset: sets offset value used in 4-20mA calibration, in A/D counts. input range: 0 to 1000	OK,IO:184/
IS	OK,IS:<i_span>/	Current Span: returns span (gain) value used in 4-20mA calibration, in A/D counts.	OK,IS:816/
ISxxxx	OK,IS:<i_span>/	Current Span: sets span (gain) value used in 4-20mA calibration, in A/D counts. input range: 0 to 1000	OK,IS:816/

0-10V VOLTAGE INPUT CALIBRATION COMMANDS

The following commands are active **ONLY** when **0-10V VOLTAGE INPUT MODE** is selected.
When **4-20mA CURRENT INPUT** is selected, instruments will respond with error message Er/.

<u>Command</u>	<u>Response</u>	<u>Description</u>	<u>Example</u>
VO	OK,VO:<v_offset>/	Voltage Offset: returns offset value used in 0-10V calibration, in A/D counts.	OK,VO:5/
VOxxxx	OK,VO:<v_offset>/	Voltage Offset: sets offset value used in 0-10V calibration, in A/D counts. input range: 0 to 1000	OK,VO:5/
VS	OK,VS:<v_span>/	Voltage Span: returns span (gain) value used in 0-10V calibration, in A/D counts.	OK,VS:1000/
VSxxxx	OK,VS:<v_span>/	Voltage Span: sets span (gain) value used in 0-10V calibration, in A/D counts. input range: 0 to 1000	OK,VS:1000/

CONSTANT PRESSURE COMMANDS

**The following commands are active ONLY for CP Class instruments.
All other instruments will respond with error message Er/.**

<u>Command</u>	<u>Response</u>	<u>Description</u>	<u>Example</u>
PS	OK,PS:<target>/	Pressure Setpoint: returns the target pressure.	OK,PS:05000/
PG	OK,PG:<p_gain>/	Proportional Gain: returns the CP algorithm P term.	OK,PG:02000/
IG	OK,IG:<i_gain>/	Integral Gain: returns the CP algorithm I term.	OK,IG:00500/
DG	OK,DG:<d_gain>/	Derivative Gain: returns the CP algorithm D term.	OK,DG:0075/
PSxxxxx	OK,PS:<target>/	Pressure Setpoint: sets the target pressure.	OK,PS:05000/
PGxxxxx	OK,PG:<p_gain>/	Proportional Gain: sets the CP algorithm P term.	OK,PG:02000/
IGxxxxx	OK,IG:<i_gain>/	Integral Gain: sets the CP algorithm I term.	OK,IG:00500/
DGxxxxx	OK,DG:<d_gain>/	Derivative Gain: sets the CP algorithm D term.	OK,DG:0075/

ETHERNET CONFIGURATION COMMANDS

The following commands are used to setup the Ethernet interface.
COMMANDS TAKE EFFECT AFTER NEXT POWER CYCLE.
CI AND NM COMMANDS ARE NOT AVAILABLE ON RS-232.

<u>Command</u>	<u>Response</u>	<u>Description</u>	<u>Example</u>
IA	OK,IA:<mode>/	IP Assignment: returns the IP address assignment mode. 0 = dynamic; assigned by DHCP. 1 = static; assigned manually.	OK,IA:1/
IP	OK,IP:<address>/	IP Address: returns the IP address.	OK,IP:10.10.0.20/
SB	OK,SB:<mask>/	Subnet: returns the network subnet mask.	OK,SB:255.255.255.0/
MC	OK,MC:<MAC>/	MAC Address: returns the MAC address.	OK,MC:bc-28-d6-ff-ff-ff/
IAx	OK,IA:<mode>/	IP Assignment: sets the IP address assignment mode. 0 = dynamic; assigned by DHCP. 1 = static; assigned manually.	OK,IA:1/
CI _{xxx.xxx.xxx.xxx}	OK,CI:<address>/	Configure IP: sets the IP address, in dot-decimal notation.	OK,CI:10.10.0.20/
NM _{xxx.xx.xxx.xxx}	OK,NM:<mask>/	Network Mask: sets the subnetwork mask, in dot-decimal notation.	OK,NM:255.255.255.0/
CM _{xx}	OK,CM:<MAC>/	Configure MAC: sets the least significant byte of the MAC address, in hexadecimal format. Other bytes cannot be changed.	OK,CM:ff/
RN	OK,RN/	Reset Network: resets network settings to default values; also resets user-adjustable values, similar to RE command.	OK,RN/

Rear Panel 10-Pin Terminal Board Connector

A 10-pin terminal board connector is provided on the back panel. Any device capable of providing the proper run/stop logic level or flow rate control voltage can be used as a remote controlling device for pump operation via this connection. The terminal board connector may be removed for ease of wiring by pulling firmly rearward. Care should be taken to reinsert the connector firmly and in the proper orientation; misalignment is possible.

<u>Pin</u>	<u>Function</u>
10	ANALOG INPUT +
9	ANALOG INPUT -
8	RELAY NORMAL OPEN
7	RELAY NORMAL CLOSED
6	RELAY COMMON
5	FAULT OUTPUT
4	ANALOG INPUT ENABLE
3	RUN INPUT
2	STOP INPUT
1	COM

Relay Output

This output is produced internally by a reed relay which has SPDT contacts with a 0.25 amp maximum, 50 VDC maximum, 0.2 ohm rating. While the pump is in a normal state of operation (no faults present), the relay terminals NORMAL CLOSED and RELAY COMMON will be electrically connected. While the pump is in a faulted state, the relay will toggle, and the NORMAL OPEN and RELAY COMMON terminals will become electrically connected.

General Information on Run, Stop, and Enable Inputs

The RUN INPUT, STOP INPUT, and ANALOG INPUT ENABLE inputs operate from an internal 3.3 VDC source. To activate any of these inputs, connect it to COM. Any device capable of switching 0.008 amps can be connected between the RUN INPUT, STOP INPUT, or ANALOG INPUT ENABLE input and COM, such as: a switch contact, a relay contact, an open collector output, an open drain output, or any output with a high logic level output of 2.6 to 5.0 volts and a low logic level output of 0.0 to 0.4 volts. A switch contact or a relay contact is preferred since this type of connection will provide isolation between the pump and the controlling device. The COM terminal is internally connected to the pump's chassis ground and should be connected to the controlling device's ground or zero volt terminal when the controlling device has an open collector output, an open drain output, or any output with logic level output.

Run and Stop Inputs

The pump's motor can be commanded to run or stop from the back panel inputs. There two modes of operation for the run and stop inputs:

Dual Signal Pulse:

In this mode of operation both the RUN INPUT and STOP INPUT are normally unconnected (floating) or at a high logic level (+3.3V). To start the pump, pulse the RUN INPUT to a low logic level (<0.4V) for a minimum of 250 ms. To stop the pump, pulse the STOP INPUT to a low logic level for a minimum of 250 ms.

Single Signal Level:

To enable this mode of operation, the STOP INPUT must be held at a low logic level during power-up. To start the pump, put a low logic level on the RUN INPUT. To stop the pump, put a high logic level on the RUN INPUT.

Analog Input Source

Control of the flow rate set point is possible via the analog input located on pins 9 and 10. To use an analog input source, the proper input mode must be selected, and the analog input must be enabled. To select 0-10Vdc VOLTAGE CONTROL, use the AM0 command or select voltage mode in the setup menu. To select 4-20mA CURRENT CONTROL, use the AM1 command or select current mode in the setup menu. Note that selecting an input mode does not enable the analog input.

Analog Input Enable

When activated (low logic level), the ANALOG INPUT ENABLE disables flow rate control via the front panel, and enables flow rate control via the analog input (0-10VDC or 4-20mA). To enable analog input mode, connect the analog input enable pin (pin 4) to ground (pin 1). Alternatively, analog input mode may be enabled without making this connection by using the AE1 command or selecting the analog input enable/override option in the setup menu.

Voltage Input

Voltage control over the flow rate set point is achieved by connecting a suitable voltage source to the ANALOG INPUT + and ANALOG INPUT – terminals. A 0-10 VDC input corresponds to a flow rate range between 0 ml/min and the pump's maximum flow rate. Voltage control mode must be both selected and enabled, as described above. The pump may be calibrated to the input source with the VO and VS commands. To avoid a ground loop, the voltage source should not be connected to the pump ground located on pin 1.

Current Input

Current control over the flow rate set point is achieved by connecting a suitable current source to the ANALOG INPUT + and ANALOG INPUT – terminals. A 4-20 mA input corresponds to a flow rate range between 0 ml/min and the pump's maximum flow rate. Current control mode must be both selected and enabled, as described above. The pump may be calibrated to the input source with the IO and IS commands. To avoid a ground loop, the current source should not be connected to the pump ground located on pin 1.

Fault Output

A TTL level output signal is located on this pin, which identifies whether the pump is operating normally (low signal level) or has faulted (high signal level).

8. APPENDIX B

Specifications for the CP-Class Pump, 5 mL/min

Flow Rate*	0.001 to 5.000 mL/min
Pressure**	0 to 25,000 psi
Pressure Accuracy	±2% of full-scale pressure
Pressure Zero Offset	-0, 30 psi
Dimensions	6.4" H x 9.9" W x 17.2" D
Weight	30 lbs
Power	100-240 VAC (±10%), 50-60 Hz, 75 W
Remote Inputs	RS-232, USB, Ethernet, Analog Input (0-10V), Digital I/O
Environmental	Indoor Use Only
Altitude	2000 M
Ambient Temperature	10° to 30° C
Humidity	20 to 90 % Relative Humidity
Fuse Ratings	2A, 250V time lag, 5x20mm size, two required per pump

Specifications for the CP-Class Pump, 12 mL/min, 18,000 psi

Flow Rate*	0.01 to 12.00 mL/min
Pressure	0 to 18,000 psi
Pressure Accuracy	±2% of full-scale pressure
Pressure Zero Offset	-0, 30 psi
Dimensions	6.4" H x 9.9" W x 17.2" D
Weight	30 lbs
Power	100-240 VAC (±10%), 50-60 Hz, 75 W
Remote Inputs	RS-232, USB, Ethernet, Analog Input (0-10V), Digital I/O
Environmental	Indoor Use Only
Altitude	2000 M
Ambient Temperature	10° to 30° C
Humidity	20 to 90 % Relative Humidity
Fuse Ratings	2A, 250V time lag, 5x20mm size, two required per pump

*Flow rate is dependent on solvent selection and operating pressure.

**5 mL/min (up to 18,000 psi) option rated for CSA.

Specifications for the CP-Class Pump, 24 mL/min

Flow Rate*	0.01 to 24.00 mL/min
Pressure	0 to 10,000 psi for Stainless Steel or Hastelloy fluid path
Pressure Accuracy	±2% of full-scale pressure
Pressure Zero Offset	-0, 2 psi
Dimensions	6.4" H x 9.9" W x 17.2" D
Weight	30 lbs
Power	100-240 VAC (±10%), 50-60 Hz, 75 W
Remote Inputs	RS-232, USB, Ethernet, Analog Input (0-10V), Digital I/O
Environmental	Indoor Use Only
Altitude	2000 M
Ambient Temperature	10° to 30° C
Humidity	20 to 90 % Relative Humidity
Fuse Ratings	2A, 250V time lag, 5x20mm size, two required per pump

*Flow rate is dependent on solvent selection and operating pressure.

Specifications for the CP-Class Pump, 100 mL/min

Flow Rate*	0.1 to 100.0 mL/min
Pressure	0 to 4,000 psi for Stainless Steel heads
Pressure Accuracy	±2% of full-scale pressure
Pressure Zero Offset	-0, 30 psi
Dimensions	6.4" H x 9.9" W x 17.2" D
Weight	30 lbs
Power	100-240 VAC (±10%), 50-60 Hz, 75 W
Remote Inputs	RS-232, USB, Ethernet, Analog Input (0-10V), Digital I/O
Environmental	Indoor Use Only
Altitude	2000 M
Ambient Temperature	10° to 30° C
Humidity	20 to 90 % Relative Humidity
Fuse Ratings	2A, 250V time lag, 5x20mm size, two required per pump

*Flow rate is dependent on solvent selection and operating pressure.

9. WARRANTY STATEMENT

Teledyne SSI (SSI) warrants that instruments or equipment manufactured by the company for a period thirty-six (36) months from date of shipment to the original purchaser (or to the drop ship location as indicated on the Purchase Order from the original purchaser), against defects in materials and workmanship under normal installation, use and maintenance. Products sold by SSI but not manufactured by SSI carry the Original Manufacturer's Warranty, beginning as of the date of shipment to SSI's original purchaser. Expendable items and physical damage caused by improper handling or damage caused by spillage or exposure to any corrosive environment are excluded from this warranty. The warranty shall be void for Polyetheretherketone (PEEK) components exposed to concentrated Nitric or Sulfuric acids which attack PEEK, or methylene chloride, DMSO or THF which adversely affect UHMWPE seals and PEEK tubing. Any defects covered by this warranty shall be corrected by replacing or repairing, at SSI's option, parts determined by SSI to be defective.

Spare or replacement parts and accessories shall be warranted for a period of twelve (12) months from date of shipment to the original purchaser against defects in materials and workmanship under normal installation, use and maintenance. Defective Product will be accepted for return to SSI only if the request for return is made within thirty (30) days from the time of discovery of the alleged defect, and prior to return, the original purchaser obtains a Return Goods Authorization (RGA) number from SSI, and provides SSI with the serial number of each instrument to be returned.

The warranty shall not apply to any Product that has been repaired or altered except by SSI or those specifically authorized by SSI, to the extent that such repair or alteration caused the failure, or to Product that has been subjected to misuse, negligence, accident, excessive wear, or other causes not arising out of a defect in material or workmanship.

The warranty shall not apply to wear items, specifically:

- Check Valves
- Piston and Wash Seals
- Pistons
- Pulse-Damper Diaphragms
- Inlet Lines
- Filter Elements

The following is the exclusive procedure by which to make claims under this warranty. Customer shall obtain SSI's oral or written authorization to return the Product and receive a Return Goods Authorization (RGA) number. The Product must be returned with the RGA number plainly visible on the outside of the shipping container to SSI. It must be securely packed in a rigid container with ample cushioning material, preferably the original packaging. All claimed defects must be specified in writing, including the RGA number, with the written claim accompanying the Product. Freight costs for the return of reported defective Product from the original purchaser to SSI is the responsibility of the original purchaser. Freight costs for the return of reported defective spare parts is the responsibility of SSI. SSI shall specify the freight carrier for returns. SSI shall bear the expense of return shipment to original purchaser (or to the drop ship location as indicated on the Purchase Order from the original purchaser).

If it appears to SSI that any Product has been subjected to misuse, negligence, accident or excessive wear, or is beyond the warranty period, the original purchaser and/or customer shall be notified promptly. SSI shall communicate its finding and provide an estimate to repair such Product at the then current rates for parts and service. SSI shall either repair the Product per customer's authorization or shall return such Product not repaired to customer at customer's expense. SSI may invoice customer for the freight costs of any Product shipped back to the original purchaser and/or customer by SSI which is not covered under the warranty.

Limitations of Warranty. THE FOREGOING WARRANTIES AND LIMITATIONS ARE CUSTOMER'S EXCLUSIVE REMEDIES AND ARE IN LIEU OF ALL OTHER WARRANTIES, EXPRESS OR IMPLIED, INCLUDING WITHOUT LIMITATION ANY WARRANTY OF MERCHANTABILITY OR FITNESS FOR A PARTICULAR PURPOSE.

10. COMPANY CONTACT INFORMATION

[Teledyne SSI](#)

349 Science Park Road
State College, PA 16803

800-441-HPLC (4752)

Technical Support: 814-234-7311

Sales: Option 2

Technical & Service Support: Option 3